

A Bulleted/Pictorial History of Mechanisms and Machines

Dr. Robert L. Williams II, Professor
Mechanical Engineering, Ohio University

© 2022 Dr. Bob Productions

williar4@ohio.edu

www.ohio.edu/mechanical-faculty/williams



South-Pointing Chariot, 240 CE China

i0.wp.com/cdn.makezine.com/uploads/2013/02/10319906.jpg

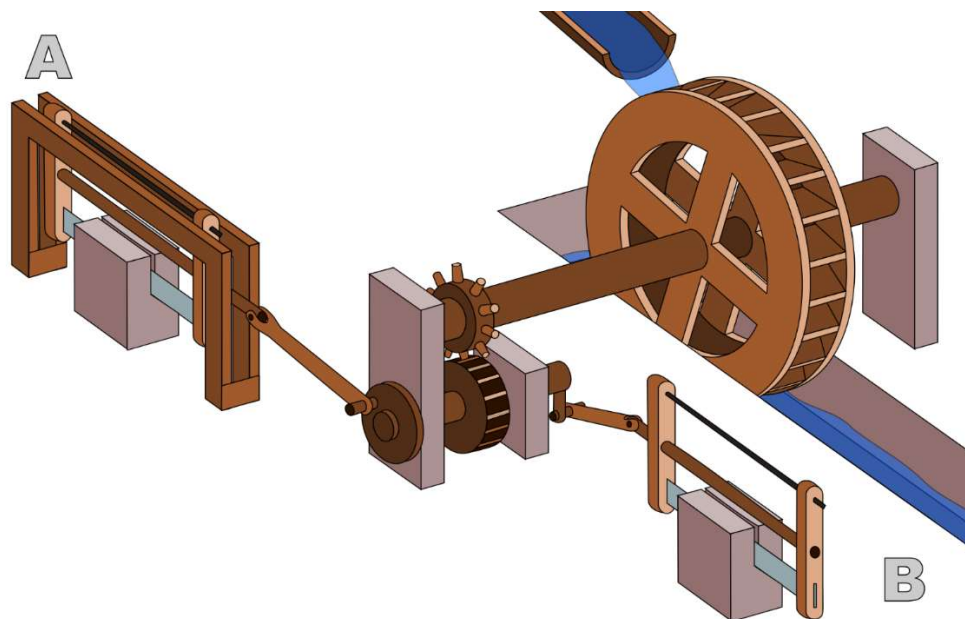

Hieropolis Sawmill, Third Century CE (Asia Minor, First Slider-Crank Mechanism)

en.wikipedia.org/wiki/Hierapolis_sawmill

Mechanisms and Machines History, Dr. Bob

Table of Contents

PROLOGUE.....	3
1. MACHINES AND MECHANISMS.....	4
2. CONCEPTS RELATED TO MACHINES AND MECHANISMS.....	8
3. IMPORTANT DEVELOPERS OF MECHANISM SCIENCE AND ENGINEERING.....	10
4. LINKAGES, GEARS, AND CAM-FOLLOWER MECHANISMS.....	14
5. SOME SPECIFIC MACHINE AND MECHANISM INVENTIONS IN HISTORY.....	25
6. IMPORTANT PERSONS IN THE HISTORY OF MECHANISMS.....	39
7. DEFINITIONS.....	45
REFERENCES.....	47

Prologue

Friends, no matter how computerized, remote, online, blue-toothicized, Internet-based, and virtualized the world becomes, **Mechanisms** will always be important! I am afraid that after the explosion of modern kinematics techniques in the 1950s – 1980s, especially as enabled by the digital computer, mechanism kinematics synthesis and analysis, plus dynamics, is not being sufficiently taught in universities today. This is due in part to pressures for reducing basic engineering coursework in favour of, ironically, more computer-based methods. In order to know how to move into the future, we must know where we came from, and, in particular, who are the giants on whose shoulders we stand. Thus, this doc was born.

My graduate training in Mechanical Engineering was at Virginia Tech in the 1980s; my **Freudenstein** academic heritage is **Freudenstein** → **Sandor** → **Reinholtz** → **Williams**. I have been presenting papers at the American Society of Mechanical Engineers (ASME) Mechanisms and Robotics Conference nearly continuously since 1986. At these events early on, Professor Charlie Reinholtz introduced me to both Professors Freudenstein and Sandor, which I appreciate very much. My undergraduate education was in Mechanical Engineering at Ohio University, where Professor O.E. Adams Jr. used the third edition of Mabie & Ocvirk. During my time at Virginia Tech, I witnessed the creation of Mabie & Reinholtz (fourth edition, 1987).

After my schooling I worked as a Space Robotist at NASA Langley Research Center for 5 years. Since then I have been Professor of Mechanical Engineering at Ohio University, teaching kinematics & dynamics of mechanisms to hundreds of undergraduate students (in addition to controls, vibrations, robotics, and biomechanics).

This document presents a bulleted and pictorial history of machines and mechanisms, tracing important mechanisms to their earliest incarnations, through the developments during the Renaissance, up to the modern computer age. This is intended to be updated periodically, so feel free to email me (yes, I go back that far!) with your suggestions, additions, deletions, errors, opinions, anecdotes, graphics, etc.

Dr. Bob
from an undisclosed location in the country near Athens OH
December 2020

1. Machines and Mechanisms

Machines

- A **Machine** is a mechanical device that takes input power to apply forces and moments to accomplish desired tasks. Modern machines (e.g. cars, boats, aircraft, spacecraft, appliances, air and water handling, machine tools, and robots, etc.) are a complicated combination of structures, mechanisms, and controls. Etymology: from the French, which came from the Latin machina, which in turn came from the Greek, contrivance, means, expedient.

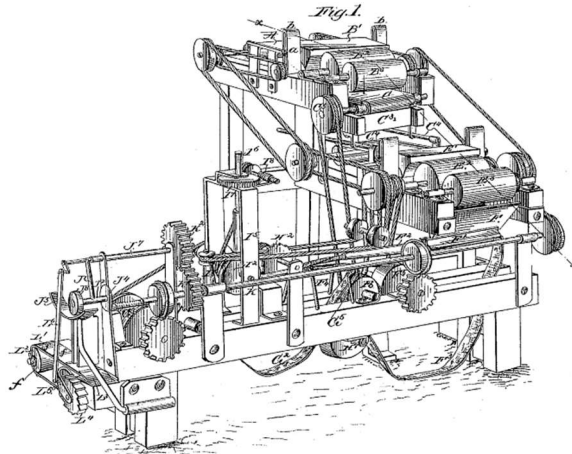

Cigarette Rolling Machine, patented in 1881 by James Bonsack

[Bonsack machine - James Albert Bonsack - Wikipedia](#)

Simple Machines

- The six **Simple Machines** (stated below in the order of appearance in history) were classified during the Renaissance, and the concept of **Mechanical Advantage** (the ratio of output force to input force) was first developed by **Archimedes** in the third century BCE. The Greeks' understanding of Simple Machines was limited to statics and did not include dynamics or the concept of work.
 1. Wedge – ancient, hand axes.
 2. Inclined Plane (ramp) – prehistoric, to move heavy masses.
 3. Wheel-and-Axle – Mesopotamia in the fifth millennium BCE.
 4. Lever – Near-East in the fifth millennium BCE.
 5. Pulley – Mesopotamia in the second millennium BCE.
 6. Screw – Mesopotamia in the first millennium BCE.

Simple Machines

You can use a **machine** to transform energy, transfer energy, multiply speed, multiply force, or change the direction of a force so you can accomplish work more quickly, easily, or both. A **simple machine** is a device that does work with only one movement.

Inclined Plane

An inclined plane is a flat surface with one end set higher than the other, such as a ramp. Variations include the wedge (2 inclined planes) and the screw (an inclined plane wrapped around a cylinder).

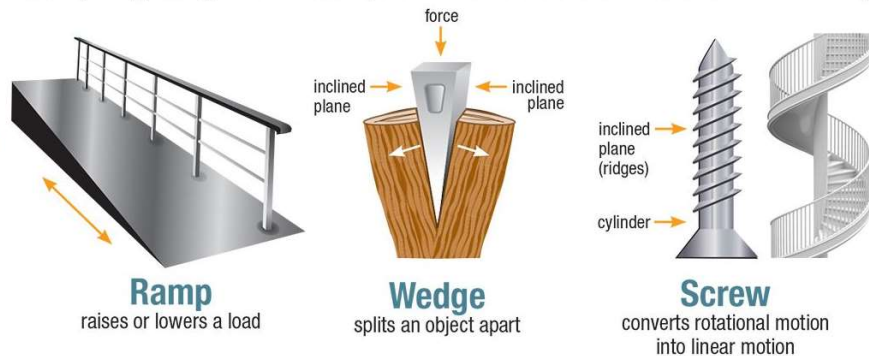

Pulley A pulley is a grooved wheel combined with a rope that allows you to raise, lower, or move a load. Types include movable and fixed pulleys. Combine them to form a block and tackle, or compound pulley.

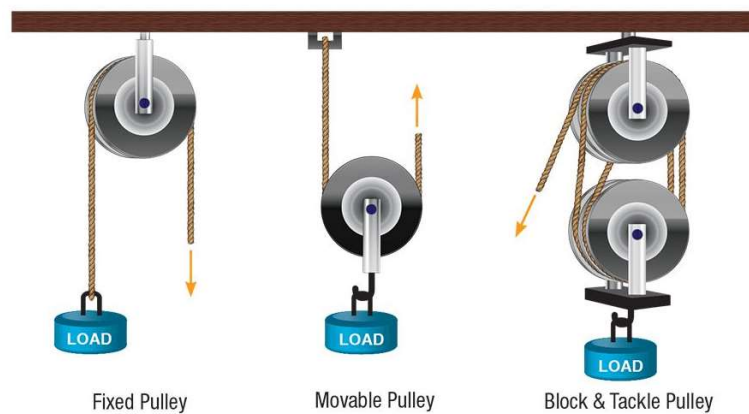

Wheel & Axle

A wheel and axle is a wheel with an axle or cylinder through its center. Both parts rotate together around the same axis to transfer force.

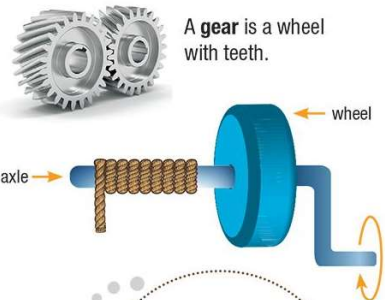

Did You Know
The wheel and axle is a special kind of lever. It's a rotating lever that turns 360 degrees around a fulcrum.



Lever A lever is a board or rod with a pivot point (fulcrum). Applied force allows you to move a load without the need to overcome friction. There are three classes of levers.

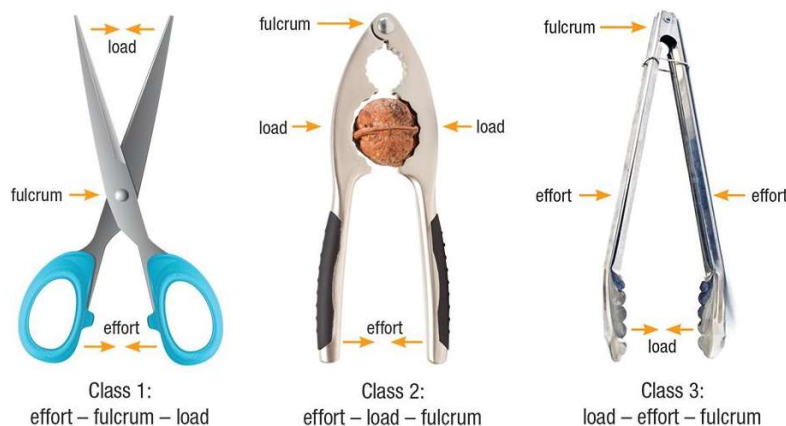

CAROLINA
www.carolina.com

The Six Simple Machines

www.carolina.com/images/teacher-resources/infographics/simple-machines.jpg

Mechanisms

- **Mechanism** is a very general English word (a means of accomplishing something). In Mechanical Engineering, it is a device that converts input motion and force/torque to output motions and force/torque. Mechanisms include linkages, gears and gear trains, cams and followers, belts and chain drives, and combinations of these. Brakes, clutches, escapements, frames, fasteners, bearings, springs, lubricants, splines, pins, and keys are also involved.
- Further, **Mechanisms** have come to indicate mechanical devices with one degree-of-freedom (as opposed to robots which have more than one degree-of-freedom). **Mobility** is defined as the number of degrees of freedom in a device (including zero or negative freedom structures). Mobility is defined and calculated by the **Grübler-Kutzbach Criterion** wherein separate equations for 2D and 3D devices are based on the number of links (having freedom) and the number and types of joints (constraining freedom).
- From **Archimedes** through the **Renaissance**, mechanisms were considered to be built from combinations of the six simple machines. German mechanical engineer **Franz Reuleaux** (1829 – 1905) instead considered **Rigid Bodies (Links)** and **Kinematic Pairs (Joints)**, the connections between bodies. Rigid bodies are a simplifying assumption whereby no link flexing nor vibration is considered. Kinematic pairs (joints) are also regarded as ideal. Reuleaux divided joints into **Lower Pairs** (surface contact) and **Higher Pairs** (line contact). He is also responsible for the ‘stick-figure’ kinematic diagrams still in use today. Reuleaux defined a **Mechanism** as “a combination of resistant bodies so arranged that by their means the mechanical forces of nature can be compelled to do work accompanied by certain determinate motion.”

Kinematic Pairs (Joints)

Useful Lower Pair Joints

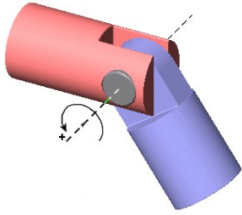

1-dof Revolute Joint R – pin or hinge joint

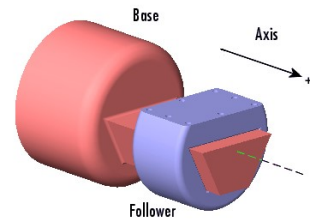

1-dof Prismatic Joint P – sliding pair

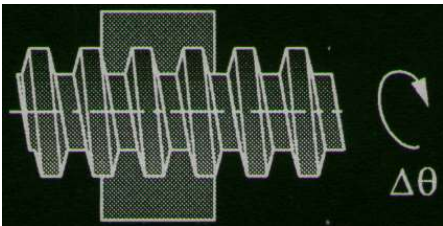

1-dof Screw joint, Helical joint

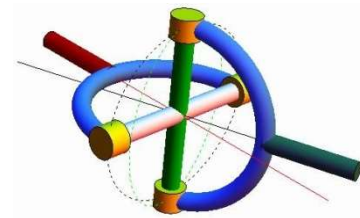

2-dof Universal joint U

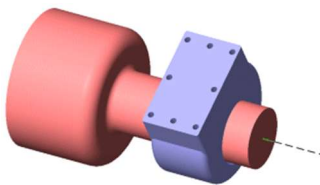

2-dof Cylindrical joint C

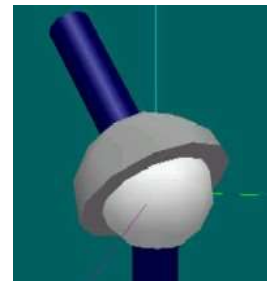

3-dof Spherical joint S

The second two lines of four lower-pair joints are for spatial (3D) motion only.

Useful Higher Pair Joints

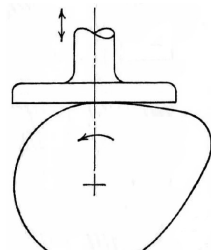

cam joint C

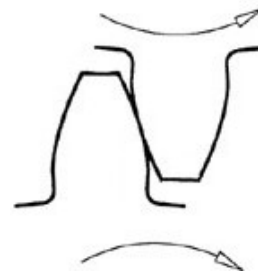

gear joint G

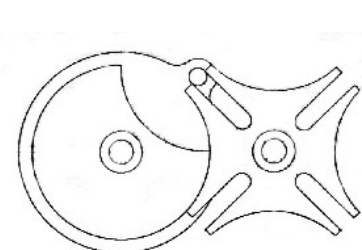

slotted pin joint SP

2. Concepts Related to Machines and Mechanisms

- **Mechanization** gives human workers machinery to assist with the muscular requirements of work. In modern engineering / economics usage, mechanization indicates machinery more complex than hand tools. After electrification, when most small machinery was no longer hand powered, mechanization was synonymous with motorized machines.
- **Automation** is the application of control systems and information technologies to reduce the need for human work in the manufacturing and service industries. Automation is a step beyond mechanization, since automation greatly decreases the need for human sensory and mental inputs. Automation plays an increasingly important role in the global economy and in daily life. Fixed automation involves 1-dof mechanisms, while flexible automation requires multiple-dof robots.
- An **Automaton** (plural: automata or automatons) is a mechanical self-operating machine. Etymology: the English word Automaton comes through Latin from the Greek, 'acting of one's own will'. Automata have been developed throughout history, by the ancient Greeks, in the Medieval period (e.g. al-Jazari, Book of Knowledge of Ingenious Mechanical Devices, 1206 CE), and especially in the Renaissance with puppets for entertainment in music, cuckoo clocks, writing humanoids, etc. As seen in the photograph below, modern humanoid robots were not the start of 'creepy' machines.



en.wikipedia.org/wiki/Automaton#/media/File:CIMA_mg_8332.jpg

- In modern usage, Automaton is sometimes used to describe an autonomous robot. Unlike mechanisms and other fixed automation, robots have more than one degree-of-freedom, and are programmable to achieve a variety of tasks. **Animatronics** are modern Automata controlled by mechatronics, in films and theme parks.

- A **Mechanical System** converts input power to accomplish a task that involving forces and motion. Modern machines are systems consisting of: 1. a power source and actuators; 2. a system of mechanisms that change the actuator input to achieve the desired application of output forces and motion; 3. a controller with sensors that compare the output to a desired goal and changes the actuator input to reduce the error; and 4. a user interface.
- **Machine Design** refers to the methods used to address the three phases of a machine's lifecycle:
 1. Invention, which involves the identification of a need, development of requirements, concept generation, prototype development, manufacturing, and verification testing;
 2. Performance engineering involves enhancing manufacturing efficiency, reducing service and maintenance demands, adding features and improving effectiveness, and validation testing;
 3. Recycle is the decommissioning and disposal phase and includes recovery and reuse of materials and components.
- **Rigid Body Mechanics** is that branch of engineering science using mathematical analysis to relate the forces/moments and translational/rotational motion of a mechanical system. The figure below shows the classical subjects comprising this topic.

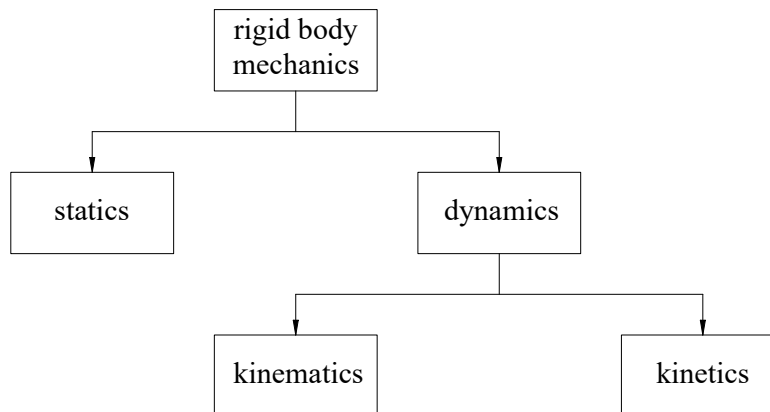

- **Kinematics** is defined as the study of motion without regard to forces and moments. **Dynamics** is the study of motion with regard to forces and moments. My students define **Statics** as the study of forces and moments without regard to motion (flipping the definition of kinematics; not bad).
- **Kinetics** is that part of dynamics connecting the kinematics motion to the **Newton-Euler** dynamic equations of motion. Check this out: kinetics involves $f = ma$; the English words kinematics and kinetics are identical, save for the **ma** (in the wrong word). That is the kind of thing that keeps me up at night!

3. Important Developers of Mechanism Science and Engineering

- **Archimedes** (287–212 BCE) studied the lever using geometry. Until the 1500s CE, **Archimedes** and **Hero of Alexandria** (circa 10 – 70 CE) were still the sources of mechanism theory.
- **Leonardo da Vinci** (1452 – 1519) rejuvenated interest and practical design methods in machines and mechanisms during the European Renaissance.
- In 1782 **James Watt** (1736 – 1819) invented the six-bar Watt’s linkage to convert rotational shaft motion into translating motion. He was a Scottish inventor, perhaps the first mechanical engineer (before that noble field was formally recognized). This was applied to separating expansion and condensation to separate cylinders in the steam engine. His linkage generates only approximate straight-line motion. The SI unit of power is named after him.
- English mathematician **James J. Sylvester** (1814 – 1897) expounded on the **Peaucellier Linkage** (invented in 1864), to generate an exact straight line from a rotating input. There are other straight-line mechanisms, many only approximate. Sylvester is also famous for matrix theory developments, and spent some of his career in the U.S. One of his great quotes is “May not music be described as the mathematics of the sense, mathematics as the music of reason?” Another great quote came from Chebyshev, writing to Sylvester: “Take to Kinematics. It will repay you. It is more fecund than geometry: it adds a fourth dimension to space.” Sylvester inspired English mathematician **Alfred B. Kempe** (1849 – 1922), who extended linkages to trace a given algebraic curve. His work led to research between geometry and computer science.
- **Franz Grashof** (1826 – 1893), a German professor of applied mechanics at the Technische Hochschule Karlsruhe, developed his famous law to determine the rotatability of the input / output links of the four-bar linkage. This is based solely on inequalities of the lengths of the four links and their arrangement. He is also responsible for the Grashof Number in free-convection heat transfer.
- In the late 1800s German **Franz Reuleaux** (1829 – 1905), Englishman **Alexander B. W. Kennedy** (1847 – 1928), and German **Ludwig E. H. Burmester** (1840 – 1927) rigorized the analysis and synthesis of linkage using descriptive geometry. Kennedy translated Reuleaux’ book (1876) into English.
- Russian mathematician **Pafnuty L. Chebyshev** (1821 – 1894) developed analytical methods for the analysis and synthesis of linkages. Kinematicians have also applied **Chebyshev Polynomials** as part of the synthesis of linkages. Specifically, Chebyshev Polynomials are used to provide optimal spacing of precision points for function generation and path generation. Chebyshev’s family name easily wins the award for most weird spellings seen out there.

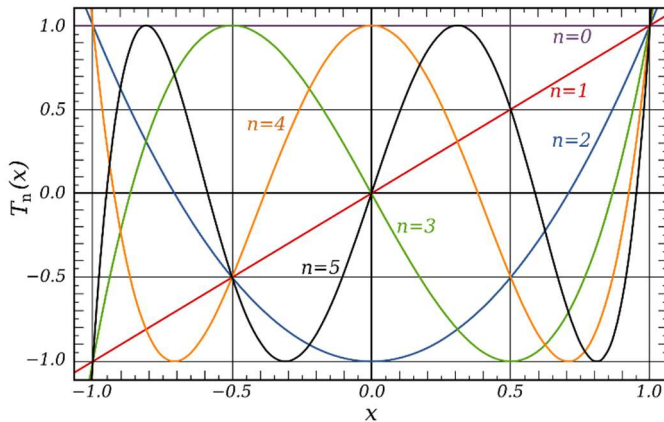

First 6 Chebyshev Polynomials of the 1st Kind

upload.wikimedia.org/Chebyshev_Polynomials_of_the_1st_Kind

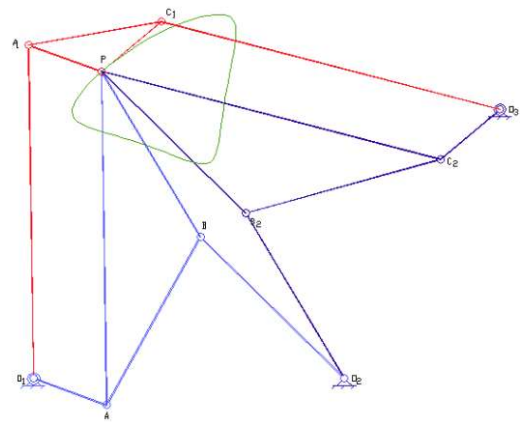

Four-Bar Linkage Cognates

Four-bar-curve-cognates.gif (wikimedia.org)

- **Cognate Linkages** have the same coupler curve (or the same input/output behavior); these can assist the process of mechanism synthesis. The **Roberts-Chebyshev Theorem** states that for a given coupler curve, there are three four-bar linkages (and three geared five-bar linkages, and even more six-bar linkages) that generate the same coupler curve. These Cognate Four-Bar linkages may be constructed using the **Cayley Diagram**. We have previously met **Chebyshev**; **Samuel Roberts** (1827 – 1913) and **Arthur Cayley** (1821 – 1895) were both British mathematicians. Cayley is also responsible for the **Cayley-Hamilton Theorem** of linear algebra. Roberts never held an academic position, and Cayley was the first Sadlerian Professor of Mathematics at Cambridge University. Professor Petru A. Simonescu generated the figure on the above right.
- Starting with the extensive **Reuleaux Collection of Mechanisms and Machines** from the 19th century, Cornell University created the **Kinematic Models for Design Digital Library (KMODDL)**, including open-access, multimedia resources for the kinematics of mechanisms, and the theory and history of machines. This is available at: engineering.library.cornell.edu/kmoddl. The German Research Foundation started the DMG-Lib (Digitale Mechanismen und Getriebelbibliothek), www.dmg-lib.org, in 2005; out of 924 articles, Professor **Kurt Hain** contributed over half!
- In the mid-1900s American engineering professors **Ferdinand Freudenstein** (1926 – 2006) and one of his 500 Ph.D. students, **George N. Sandor** (1929 – 1996), initiated the computer-aided design of mechanisms at Columbia University. They used the new digital computers (developed during WWII for trajectory calculations) to solve the loop equations of a mechanism and to perform mechanism synthesis (design the linkage dimensions to perform rigid-body guidance, function generation, or path generation). By the mid-1970s these computer methods became important in the analysis, synthesis, and control of complicated machines and robot manipulators. Freudenstein is known as the “Father of Modern Kinematics” and his influence is so profound, a “Freudenstein Doctoral Descendent Tree” (<https://sites.google.com/view/freudensteintree>) has been developed and maintained by Prof. Pierre Larochelle (**Freudenstein** → **Roth** → **McCarthy** → **Larochelle**). Today this tree has over 750 names and 7 generations of Ph.D. students. Your humble current author is also on this fourth-generation level (**Freudenstein** → **Sandor** → **Reinholtz** → **Williams**).



Ferdinand Freudenstein



George N. Sandor

- The first U.S. **Mechanisms Conference** was held at Purdue University in 1953. A decade later ASME started the ASME Biennial Mechanisms Conference, in 1964. The conference was renamed the ASME Biennial Mechanisms and Robotics Conference in 2000. Starting in 2005 the conference became the annual ASME Mechanisms and Robotics Conference. It continues to be held annually as part of the ASME International Design Engineering Technical Conferences. The **South-Pointing Chariot Award** has long been awarded annually as one of the best paper awards at this conference. There have been fifteen **International Federation for the Promotion of Mechanism and Machine Science (IFToMM) World Congresses** (International Federation for Promotion of Theory of Mechanisms and Machines, founded by Professor Francis Rendel Erskine Crossley, 1915 – 2017) between 1965 and 2015. The **Applied Mechanisms Conference**, led by Abe Soni, was held for many years, starting in 1970, and held generally on odd off-years of the ASME Mechanisms Conference, through the **Sixth National Applied Mechanisms & Robotics Conference** in Cincinnati in 1999.
- In 1955 **Jaques Denavit** (1930 – 2011) and **Richard S. Hartenberg** (1907 – 1997) published their seminal paper. These so-called **Denavit-Hartenberg (DH) Parameters** were proposed to standardize the attachment of dextral Cartesian coordinate frames to links in the analysis of spatial mechanisms. Later, roboticists appropriated **DH Parameters** for the same reason in the analysis of serial robot manipulators (Paul, 1983; Craig, 1986, modified DH Parameters).
- Sandor's Ph.D. student **Roger E. Kaufman** created the interactive computer software **KINSYN** (1971) for linkage synthesis. He used computer polynomial root-finding algorithms and combined Freudenstein's and Sandor's analytical techniques with the geometrical methods of Reuleaux and Burmester.
- Professor **Art Erdman** (University of Minnesota; **Freudenstein** → **Sandor** → **Erdman**) and his team created the software **LINCAGES** (**L**inkage **I**nteractive **C**omputer **A**ssisted **G**eometrically **E**nhanced **S**ynthesis) in 1985 to assist the user with synthesis and analysis of planar four-bar and six-bar mechanisms (dept.me.umn.edu/labs/lincages). Professor **Mike McCarthy** (University of California, Irvine; **Freudenstein** → **Roth** → **McCarthy**) and his team created the software programs **Sphinx**, **Synthetica**, and **MecGen** for computer-aided design of spherical and spatial linkages.

- Here are some of the important **Journals** in the area of mechanism kinematics & dynamics: The International Federation for the Promotion of Mechanism and Machine Science (IFToMM) published the Journal of Mechanisms (1966 – 1971), which morphed into Mechanisms and Machine Theory (1972 – present). The next series has gone through three names to date: ASME Journal of Mechanisms, Transmissions, and Automation in Design (1983 – 1989), ASME Journal of Mechanical Design (1990 – 2008), and ASME Journal of Mechanisms and Robotics (2009 – present). The ASME Journal of Dynamic Systems, Measurement, and Control (1971 – present) often has articles of interest to our community. A newer journal of interest is the International Journal of Mechanisms and Robotic Systems (2013 – present). All current ASME Journals branched from the ASME Transactions initiated in the 1880s. The ASME Journal of Engineering for Industry was the precursor for the ASME Journal of Mechanisms, Transmissions, and Automation in Design (though, as the name indicates, the subject matter was much broader than mechanisms).
- **Compliant Mechanisms** have garnered a large research interest in recent decades. These are generally flexible mechanisms wherein the ‘joints’ are simply thinner flexible portions of the material. Picture a shampoo bottle lid – that is a compliant four-bar mechanism (presented by Professor Reinholtz in a Virginia Tech seminar during the mid-1980s). Compliant Mechanisms are complicated relative to conventional jointed rigid-body linkages because the statics, kinematics, dynamics, and strength-of-materials problems are all coupled. Many researchers have contributed to this field, but here we mention Prof. **Larry Howell** of BYU (whose textbook on the subject appeared in 2001), and his advisor Prof. **Ashok Midha**, a gentleman and scholar who, for reasons unknown, took a young Dr. Bob under his wing at the ASME Mechanisms Conferences. (Larry, though of an age with Dr. Bob, is fifth generation: **Freudenstein** → **Sandor** → **Erdman** → **Midha** → **Howell**.)
- Modern computer-based **Kinematics & Dynamics** techniques are applied to **linkages, robots, machine tools, cable-driven robots, cable-suspended robots, and tensegrity systems**, plus to **biomechanics** and the study of **proteins**.
- The **Internet** is a rich source for animations of various useful mechanisms (the reader is invited to **Google** for many interesting pages). For example, Professor Petru A. Simonescu has posted many interesting .gif animations of mechanisms and robots on Wikimedia Commons:

[Uploads by Pasimi - Wikimedia Commons](#)

4. Linkages, Gears, and Cam-Follower Mechanisms

Linkages

- A **Linkage** is a collection of links connected by joints. The rigid links are the structural elements and the joints (kinematic pairs) allow movement. The most common and useful examples are the planar **Four-Bar** (we must count the ground link) and **Slider-Crank** (also a four-bar) **Linkages**.



Four-Bar Linkage



Slider-Crank Linkage

reuleauxmodels.com

- The **Slider-Crank Linkage** is the most ubiquitous mechanism in the world, with perhaps one billion in existence (KMODDL, Cornell University Library).
- The **Hierapolis Sawmill** was a water-powered Roman stone and wood sawmill at Hierapolis (Asia Minor). Developed in the second half of the 3rd century CE, this sawmill is acknowledged as the earliest known **Slider-Crank Mechanism**. It had two slider-crank mechanisms, driven by the same waterwheel power source, for sawing wood and stone.

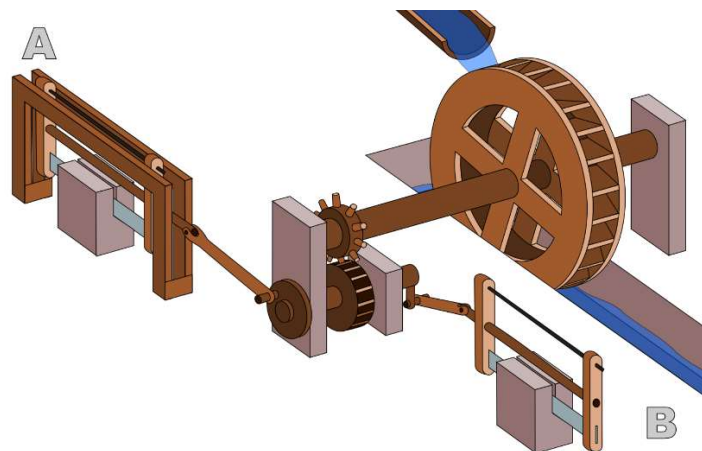

Hierapolis Sawmill

Hierapolis sawmill

- The first **Four-Bar Linkage** in history is not as easy to ascertain as the slider-crank above. In 1962 E.S. Ferguson stated “While I am not aware of unequivocal evidence of the existence of four-bar linkages before the 16th century (CE), their widespread application by that time indicates that they probably originated much earlier.” ([Kinematics of Mechanisms from the Time of Watt \(cornell.edu\)](#)) This same reference goes on to show a possible four-bar linkage in a design for an up-and-down sawmill from the 13th century (CE), shown below (lower left, which image Ferguson credited to Robert Willis, 1800 – 1875).

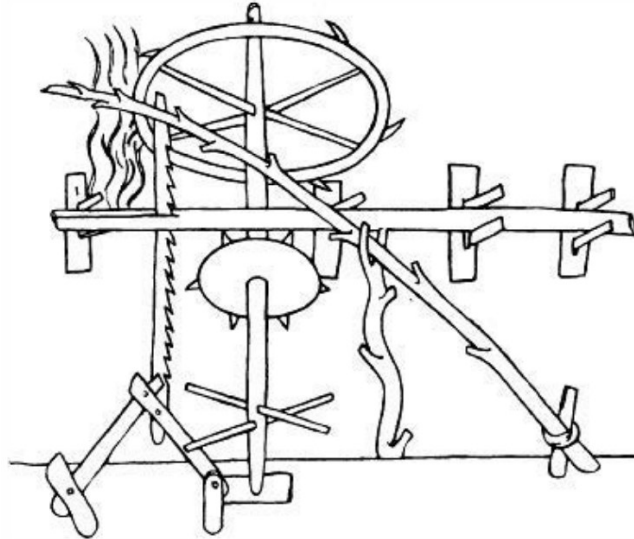

13th Century CE Four-Bar Linkage, Up-and-Down Sawmill

- **Watt's Linkage** is a **Four-Bar Linkage** that generates an approximate straight line, crucial to the development for his steam engine. This linkage is also used automotive suspensions, preventing side-to-side movement of the chassis relative to the wheels.
- The Watt's approximate **Straight-Line Linkage** led to the design of other approximate straight-line linkages (Hoeken's linkage and Chebyshev's linkage). The **Peaucellier Eight-Bar Linkage** generates exact straight-line output from a rotating input.
- The **Sarrus Linkage** is a spatial linkage that generates straight-line motion from a rotary input.
- The **Klann Six-Bar Linkage** and the **Jansen Eight-Bar Linkage** provide 1-dof walking movements. The left photo below shows a scale model of two Jansen eight-bar linkages driven by the same shaft. These are used by Dutch kinetic sculptor Theo Jansen in his Strandbeest (beach beast) wind walkers.

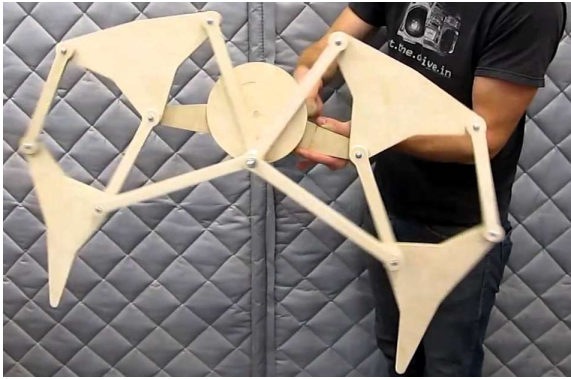

Jansen Eight-Bar Linkages

maxresdefault.jpg (yting.com)

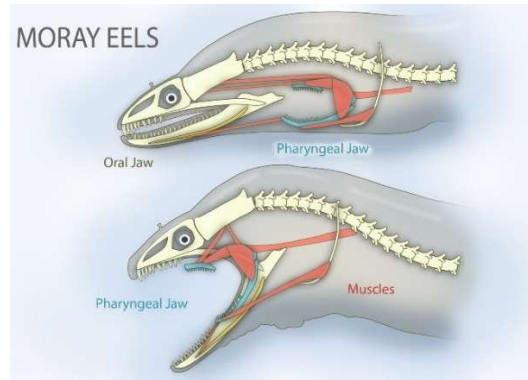

Moray Eel with Pharyngeal Jaw

wikipedia/commons/e/e3/Pharyngeal_jaws_of_moray_eels

- **Moray Eel has second set of jaws.** The predatory moray eel has a secondary, retractable, upper and lower set of jaws and teeth. Called the **Pharyngeal Jaw**, this can be seen in the figure above. This evolutionary adaptation helps grip prey as the main jaws let go to rotate the prey head-first into the eel's mouth. This pharyngeal jaw can be modeled with a complicated planar mechanism / robot. The **Parrotfish** has a similar pharyngeal jaw.
- A **Pantograph** is a linkage based on parallelograms such that the motion of one pen traces a scaled copy (up or down) of the original. Ancient Greek experimenter **Hero of Alexandria** presented pantographs in his writings. U.S. founding father **Thomas Jefferson** used one to copy his letters as he wrote. In addition to writing, the pantographs are used for duplication in sculpture, minting, engraving, and milling. The duplication pantograph has two-dof, able to follow XY inputs of the writer. A pantograph also refers to a one-dof scissor mechanism such as a wall-mounted mirror and scissor lift in construction. Etymology: Greek 'all' + 'to write'.

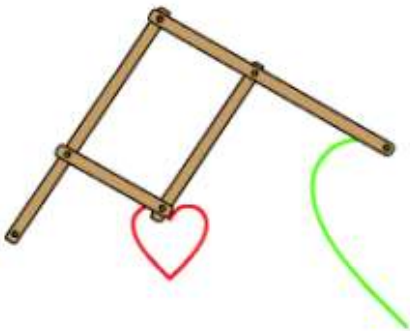

Duplication Pantograph

en.wikipedia.org/wiki/Pantograph

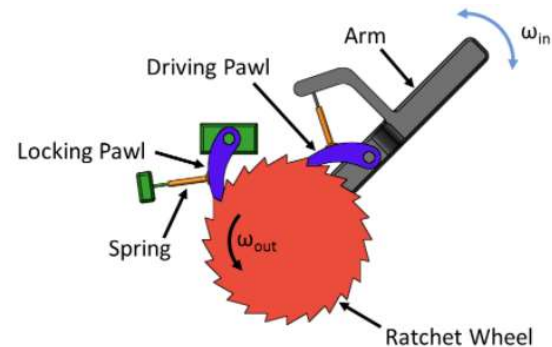

Ratchet-and-Pawl Mechanism

[Ratchet and Pawl Mechanism \(freecaptitudecamp.com\)](http://Ratchet and Pawl Mechanism (freecaptitudecamp.com))

- A **Ratchet-and-Pawl Mechanism** may be seen as a combination of gear pair and linkage. It is an **Intermittent-Motion Mechanism**, allowing rotation of an output shaft in one direction only (preventing motion in the opposite direction). The oscillating motion of the input link is converted into rotary output. The two pawls (driving and locking) are generally spring loaded for positive contact.

- Another intermittent-motion device is the **Geneva Wheel Mechanism**, so-named since it was originally used in mechanical watches and clocks in Switzerland. It is also called the **Maltese Cross** when there are four slots as shown in the figure below. There can be any integer number of slots (but 4 and 6 are the most common) and the driven wheel rotates intermittently (360 degrees divided by that integer) as the drive wheel rotates continuously. The connection between wheels is a higher-pair joint, called a slotted-pin joint. When the pin (rigidly connected to the drive wheel) contacts the slot, there is a discontinuity in acceleration and hence an undesirable infinite spike in jerk.

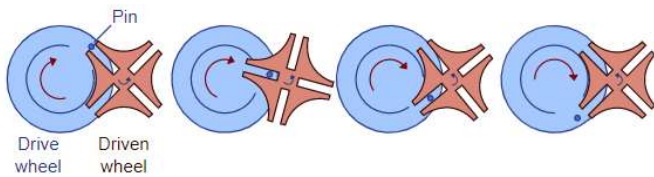

Geneva Wheel Mechanism

upload.wikimedia.org/wikipedia/commons/c/cf/Geneva_drive.svg

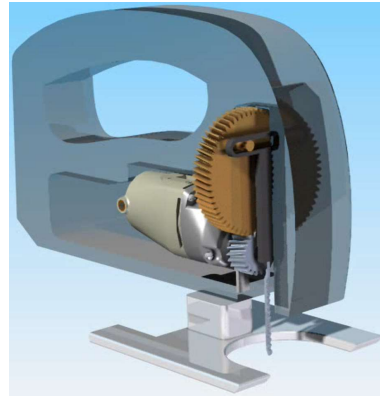

Scotch Yoke Mechanism

ohio.edu/mechanical-faculty/williams/html/MechanismAnimations

- The slotted-pin joint also appears in the **Scotch Yoke Mechanism**, continuously converting input rotation to reciprocating translating motion (or vice versa). For a continuously rotating input, the output translation provides **Simple Harmonic Motion**. An application is shown above for a hand-held jigsaw. Helical gearing is also shown (not necessary to define a Scotch Yoke Mechanism), to transmit input motor rotation to the mechanism rotary input. Other applications include control valves, engines, and mechanical film projectors.

- **Quick-Return Mechanisms** are linkages used in machining wherein there is a long, steady cutting stroke motion, and a faster return unloaded to make the next pass. The **Whitworth Mechanism** is an example, invented in the mid-1800s by English entrepreneur **Joseph Whitworth** (1803 – 1887). This is a compound **Six-Bar Linkage** with a continuously-rotating input. The Quick-Return Mechanism was another enabling technology for the **Industrial Revolution**. Whitworth also **standardized screw threads** in Britain and developed the first **sniper rifle**.

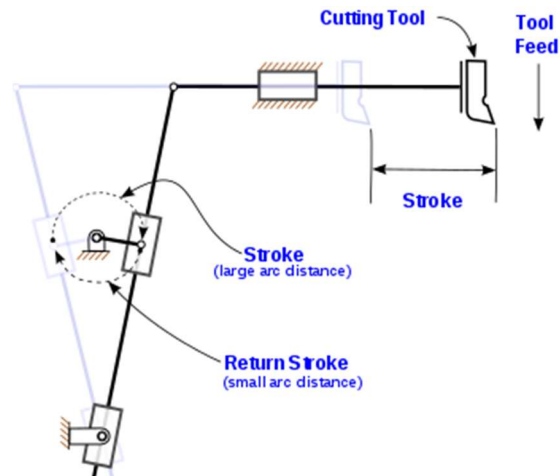

Whitworth Quick-Return Mechanism

en.wikipedia.org/wiki/Quick_return_mechanism

- The **Double Slider-Crank Mechanism**, also called the **Trammel of Archimedes** (287–212 BCE), consists of two sliders in perpendicular slots, connected by a single rotating link. As shown below, the link end traces out an ellipse. This is a favourite analysis problem in sophomore dynamics classes everywhere. This mechanism also appears in the **Oldham Coupling**. Irish inventor **John Oldham** (1779 – 1840) developed this coupling in 1821 for a paddle-wheel steamship.

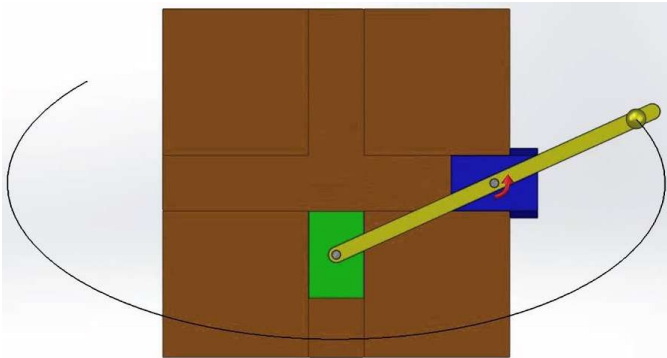

Trammel of Archimedes

maxresdefault.jpg (yting.com)



Oldham Coupling

oldham+coupling.JPG (bp.blogspot.com)

Gears

- A **Gear** is a rotating circular link with machined teeth (formerly, cogwheels had inserted teeth), which mesh with another gear to transmit rotational motion and torque between shafts. Gears of different sizes (pitch radii, numbers of teeth) directly change torque, and inversely change rotational motion, via the gear ratio. Gears are the closest mechanism to a simple machine, the wheel-and-axle. Modern high-speed gears use an involute tooth profile so that their torque and speed ratios do not change with changes in center distance (to allow for thermal expansion). Two or more meshing gears are called a gear train. A rotational gear (pinion) can also mesh with a translational rack, a toothed linear link (whose pitch circle radius is infinite).

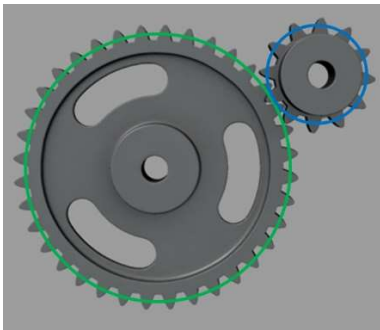

Externally-meshing Spur Gears

Dr. Bob Productions, 2020



Rack & Pinion

[Classification-of-Gears-extrudesign.com-232007.png](https://www.extrudesign.com-232007.png)

- **Gears** were first described by the Greek mathematician **Archimedes** (287–212 BC). Gears later appeared in the writings of **Hero of Alexandria** (circa 50 CE).
- The first known use of **Gearing** is the **Antikythera Mechanism** (also called the **Delphic Mechanism**, the first mechanical analog computer) of ancient Greece (150 BCE), used for calculating astronomical positions, including future eclipses. It is a combined clock, calendar, and astrolabe, centuries ahead of its time. This involved an **Epicyclic Gear Train** wherein gears rotate about their own axis and about a sun gear. The Greeks came up with the **Epicycle** circa 500 BCE. Modern epicyclic gear trains are called **Planetary Gear Trains**. These have two-dof (so the sun gear is often fixed to ground) and are used in bicycles, airplane propeller transmissions, etc.



Antikythera Mechanism

en.wikipedia.org/wiki/Antikythera_mechanism



South-Pointing Chariot

en.wikipedia.org/wiki/South-pointing_chariot

- The **South-Pointing Chariot** of China (circa 240 CE) was invented by **Ma Jun**. This ingenious device used gears to always point south, no matter the heading of the cart (after manual setting towards south before starting).
- Renaissance scientist **Georgius Agricola** made drawings of gear trains with cylindrical teeth.
- The **Segmental Gear**, wherein the circle of the gear is partial (i.e. a sector), was developed by Kurdish inventor **al-Jazari** in 1206, as part of a water-lifting machine.

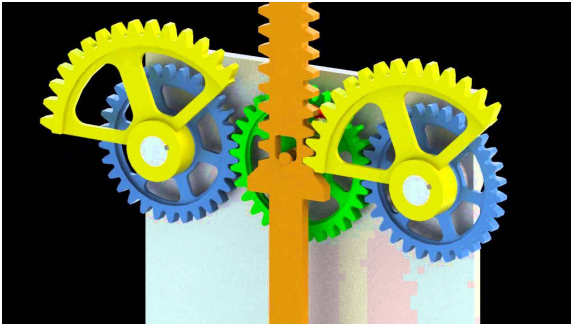

3D-Printed Segmental Gears in Yellow

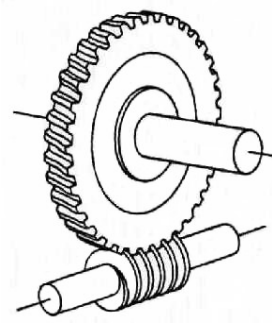

Worm and Gear

Mabic & Reinholtz (1987)

- The **Worm Gear** was invented in India during the 13th century CE, for use in the existing **Roller Cotton Gin** (India, 6th century CE).
- **Differential Gear Transmissions** have two output shafts that can rotate at different angular speeds while being powered by rotation of an input shaft. Differential gears may have been used in the **Antikythera Mechanism** and the **South-Pointing Chariot**, but the first verifiable use of differentials in clocks was in 1720 by Englishman **Joseph Williamson**. In the modern era, differentials were used in old-fashioned rear-wheel drive cars so the driven wheels may be powered smoothly with the drive shaft from the engine, while rotating at different angular speeds for cornering.

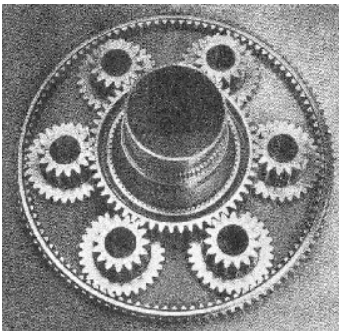

Modern Planetary Gear Train

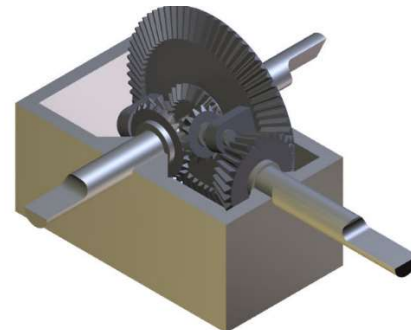

Automotive Differential

- **Gears found in nature for the first time.** Biomechanicists state that the only simple machine found in the human body (and animals) is the lever (all three classes appear). Some physiologists also consider pulley systems to exist at the human knee and fingers. For the first time in 2013 it was discovered that the tiny jumping insect (the juvenile Issus) has evolved biological gears to enable extreme (powerful, high acceleration) jumping during its juvenile period. According to scientists at the University of Cambridge, the juvenile Issus insect has hind-leg joints with curved cog-like strips of opposing teeth that mesh, rotating like mechanical gears to synchronize the animal's legs when it launches. Both sides have 10-12 teeth for a 1:1 gear ratio. The gears ensure that both hind legs move at the same angular velocities to propel the body without yaw rotation, to avoid catastrophic loss of control. The Issus, a plant-hopping insect found in gardens across Europe, loses this feature at adulthood, possibly because if a tooth is damaged while young, the next molt can repair it, which is impossible after adulthood.



Juvenile Issus Insect

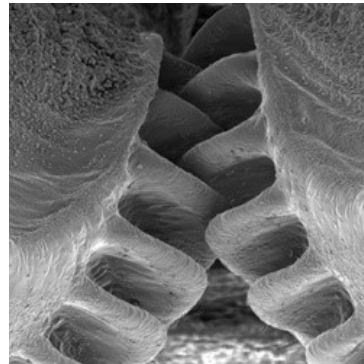

Biological Hind-leg Gears

M. Burrows and G. Sutton, 2013, Interacting Gears Synchronize Propulsive Leg Movements in a Jumping Insect, *Science*, **341** (6151).

Cam-Follower Mechanisms

- A **Cam** is an irregularly-shape link used to transmit rotating (or translating) input to translating (or rotating) output motion. A cam can be an eccentric wheel or irregularly-shaped shaft that interfaces with a follower link. A cam timer was used for electric machine control before the advent of microcontrollers.
- **Cam Mechanisms** first appeared circa 600 BCE in China, in a crossbow trigger-mechanism. Ancient Chinese technology did not use fully-rotating cam shafts. Cams were then used in Chinese water-powered trip hammers circa 200 BCE. During the Tang dynasty, many cam mechanisms are documented: wooden clock in an astronomical device, spurs inside an armillary sphere, automated alarm in a sand-driven clock, paper figures in a revolving lantern, and a odometer.
- **Continuously-Rotating Cams** were implemented in the third century BCE for water-powered Greek automata. The cam and camshaft later appeared in automata by al-Jazari and Shooshtari (1206). The cam and camshaft appeared in European machines in Europe during the 14th century.
- **Cam-Follower Mechanisms** are implemented in the internal combustion engine, opening and closing intake and exhaust valves smoothly (and keeping them open/closed for the right amount of time) during the full cycle of motion. Old-fashioned automotive engines accomplished this strictly mechanically, powered and timed from the drive shaft, via belts and/or gearing. Compared to linkages, it is easier to design desired motion with cams (with theoretically infinite precision points), but they are more expensive and difficult to produce. Also, the cam contact and wear properties are worse than for linkages.
- The following diagram shows the four phases of motion in a **Four-Stroke Internal Combustion Engine** (intake, compression, power, exhaust) and the two associated valves (cams not shown).

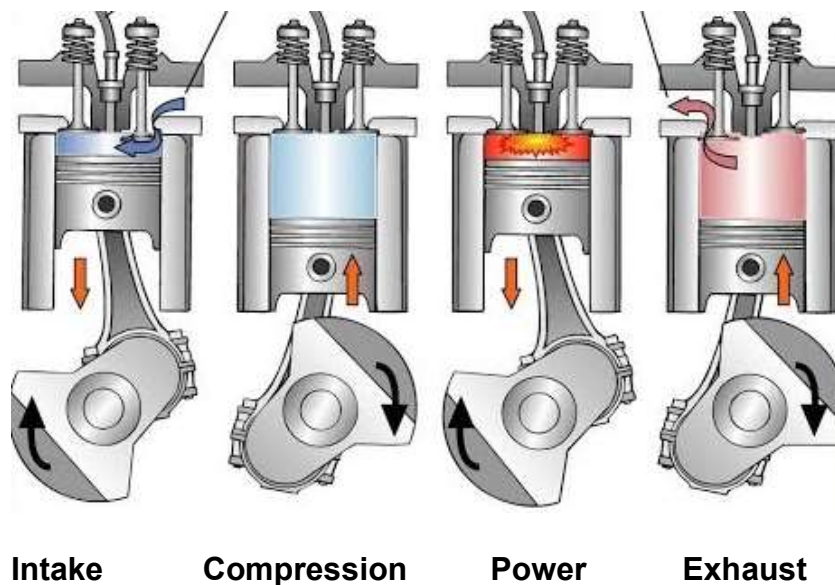

The Four Motion Phases of a Four-Stroke Engine

[hqdefault.jpg \(480x360\) \(yting.com\)](#)

- The next graphics show the **Classification of Planar Disk Cams** and various **Followers** (translating and rotating, knife-edge, flat-faced, and roller followers).

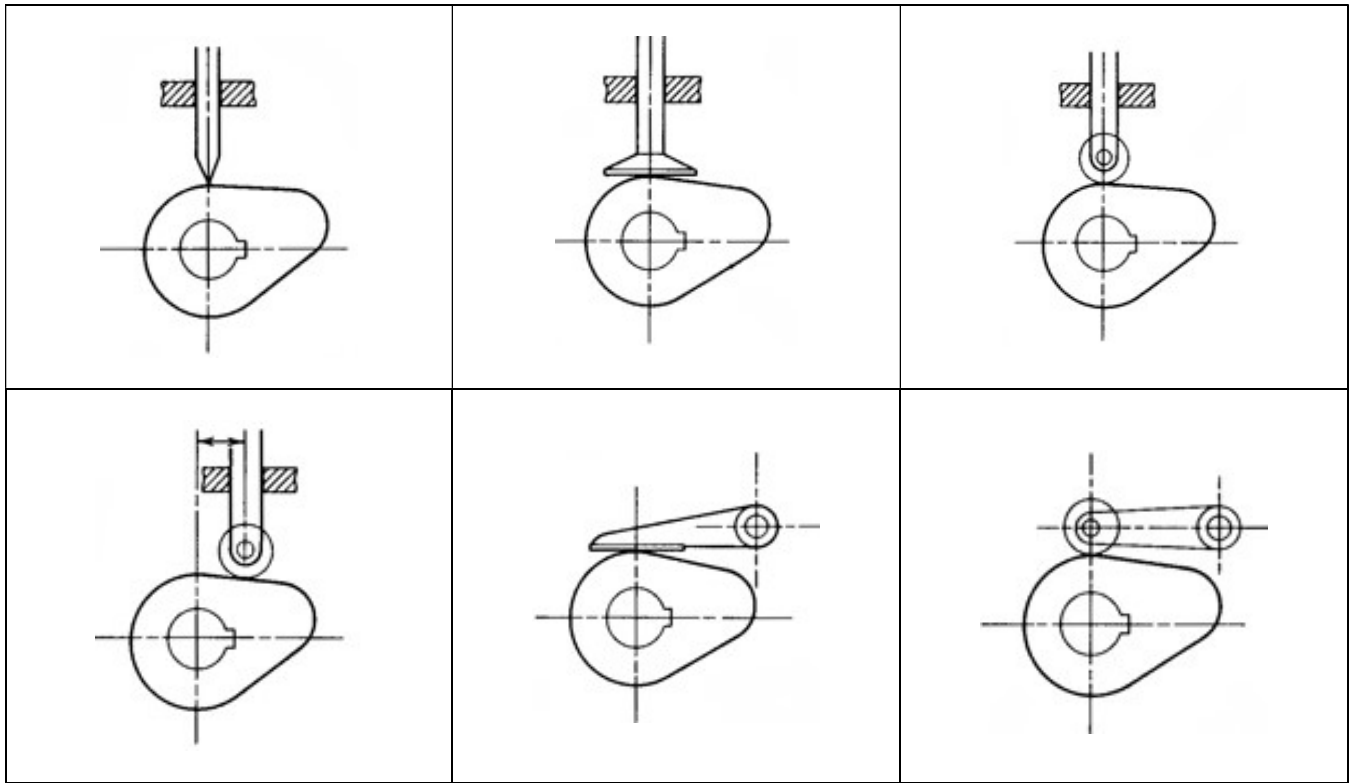

Classification of Disk Cam and Followers

Mabie & Reinholtz (1987)

disk cam with translating knife-edge follower	disk cam with translating flat-faced follower	disk cam with translating roller follower
disk cam with offset translating roller follower	disk cam with rotating flat-faced follower	disk cam with rotating roller follower

Mechanical Computers

- **Mechanical Computers** were constructed using cams, gears, and linkages.
- In 1837 English mathematician **Charles Babbage** (The Father of the Computer, 1791 – 1871) designed computing machines to calculate logarithms and other functions. His **Difference Engine** was a mechanical calculator and his Analytical Engine was an ancestor to modern digital computers (but none were built in Babbage's lifetime). Italian **Ada, Countess of Lovelace**, corresponded with Babbage, and is considered the first computer programmer, developing algorithms and the concept of punch cards.
- The **Arithmometer** was patented in 1820 by Frenchman **Charles Xavier Thomas de Colmar** (1785 – 1870); this became the first commercial calculator successful enough to replace human calculations. The **Comptometer**, patented in 1887 by **American Dorr E. Felt** (1862 – 1930), was the first key-input mechanical calculator, and was produced through the 1970s. Both machines are precursors to modern digital computers (developed during WWII).

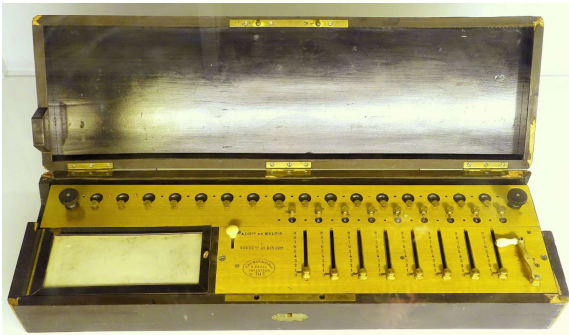

Arithmometer

[Arithmometer \(wikimedia.org\)](https://commons.wikimedia.org/wiki/File:Arithmometer.jpg)

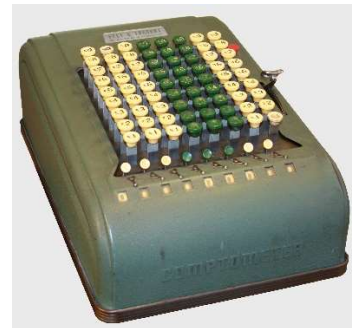

Comptometer

[Comptometer_Model_WM.jpg \(wikimedia.org\)](https://commons.wikimedia.org/wiki/File:Comptometer_Model_WM.jpg)

- When working as a space roboticist at **NASA Langley Research Center** in Hampton, Virginia (1989 – 1994), **Dr. Bob** met some women near retirement who had served as ‘**Human Computers**’ during the **Apollo Mission** in the 1960s. Then, they sat in a room with desks arranged like a matrix, received sheets from other humans, did their own calculations, and then passed their results on to the next human in the process. In this manner, they could numerically solve differential equations, and other complicated problems, as a team. Most had retooled themselves as programmers of digital computers, still employed by NASA. NASA Langley Research Center was also the setting for the excellent Hollywood film **Hidden Figures**.

5. Some Specific Machine and Mechanism Inventions in History

- The invention/discovery of the **Wheel** was around 5000 BCE, well before the concept of Intellectual Property. Dung beetles and tumbleweeds are credited with giving ancient humans the concept for the Wheel.



The Wheel (public domain)

il.wp.com/www.learning-history.com

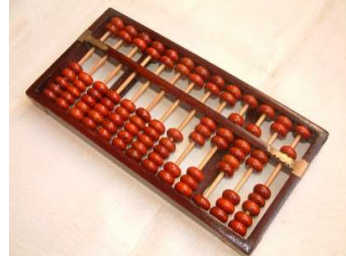

Abacus

en.wikipedia.org/wiki/Abacus

- The invention of the **Abacus**, the first counting machine, was in 3000 BCE in Babylon.
- The **Flush Toilet and Sewer System** first appeared in India around 2600 BCE.

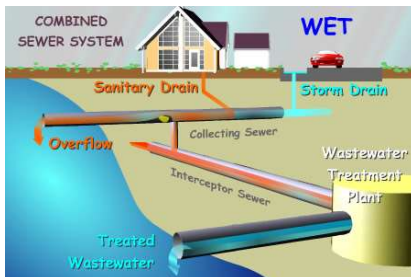

Modern Sewer System

CombinedSewer.jpg



Early Wheelbarrow

www.thoughtco.com

- The **Wheelbarrow** was invented in 407 BCE.
- The earliest practical water-powered machine **Watermill** first appeared in the Persian Empire, by the early 4th century BCE.



Watermill

hqdefault.jpg

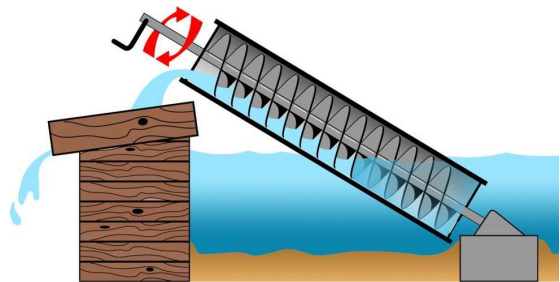

Archimedes' Screw

ArchimedesscrewA.jpg

- **Archimedes' Screw**, a simple and effective water pump, was developed in 300 BCE.

- The first **Canal Lock** was built in the ancient Suez Canal, 283 BCE.



Ancient Suez Canal

[wikimedia.org/commons/Canal_of_the_Pharaohs](https://commons.wikimedia.org/wiki/File:Canal_of_the_Pharaohs)



Waterwheel

[Roda_de_Vitruvi.jpg](#)

- The **Waterwheel** was invented in Greece in 280 BCE.



Chinese Seismoscope

[East_Han_Seismograph.jpg](#)

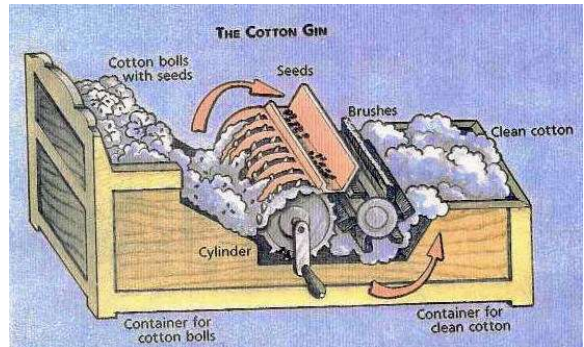

Cotton Gin

[cotton+gin.jpg](#)

- A **Seismoscope** for sensing and measuring earthquakes was made in the Han Dynasty of China, in 132 CE.
- The **Cotton Gin** (engine) was invented in India by the 6th century CE.

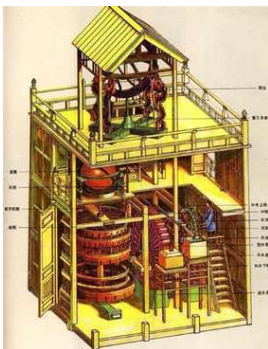

Chinese Geared Mechanical Clock

[Mechanical-Clock.jpg](#)

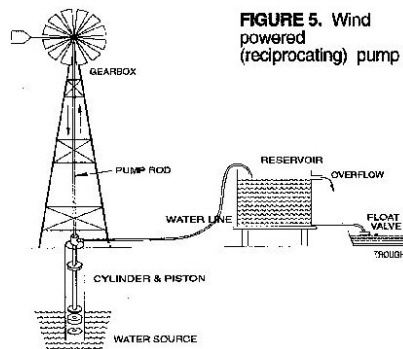

FIGURE 5. Wind powered (reciprocating) pump

Windmill Water Pump

[pumps-cattle.jpg \(pinimg.com\)](#)

- The first geared **Mechanical Clocks** were made in China (725 CE).

- The **Windmill** and **Wind Pump**, the earliest wind-powered machines, were built in the 9th century CE during the Islamic Golden Age (present-day Iran, Afghanistan, and Pakistan).
- The earliest **Programmable Machines** (music sequencers) were developed in the Islamic world. The first was an automated flute player invented by the Banu Musa brothers in the 9th century CE (Book of Ingenious Devices). This involved pins on a rotating drum that was driven by a water wheel, similar to music boxes familiar to us.

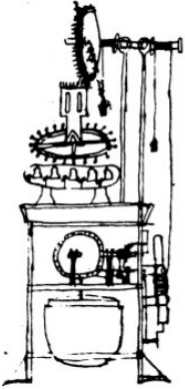

Automated Flute Player

[automated flute player invented by the Banu Musa](#)



Spinning Wheel

[spinningwheel.jpg \(300x352\) \(quatr.us\)](#)

- The **Spinning Wheel** was invented in the 11th century in the Islamic world. Along with the earlier Cotton Gin from India, these inventions facilitated the expansion of the cotton industry.
- Kurdish inventor **al-Jazari** (1136 – 1206) developed many important mechanisms and machines during the Islamic Golden Age, e.g.: 1. The **Crankshaft** and **Camshaft** (critical in modern machines such as the steam engine, internal combustion engine, and automatic controls). 2. **Programmable Automata** (drumming humanoid musicians). 3. The **Castle Clock**, a water-powered mechanical astronomical clock (an early programmable analog computer).



Castle Clock

[24727208561_e24fa36a75.jpg \(staticflickr.com\)](#)



Astrolabe

[41314_450.jpg \(imss.fi.it\)](#)

- The geared **Astrolabe** was made in Isfahan (1221 CE), showing the position of the moon relative to the stars, and its phase and number of days since the new moon.

- The **Salisbury Cathedral Clock** (1386) in England is the world's oldest geared mechanical clock that is still functioning.



Salisbury Cathedral Clock

[Salisbury_Cathedral_Clock.jpg \(thoughtco.com\)](http://thoughtco.com)



Gutenberg Printing Press

[Printing_press_1.jpg \(wikimedia.org\)](http://wikimedia.org)

- In 1450 **Johannes Gutenberg** invented the **Printing Press** based on screw presses. The printing press could easily reproduce images repeatedly, allowing books and documents to be printed to help disseminate and preserve them. This ability to reproduce books helped education because more people could own books to read and schools had more books to study from. This machine sped up the printing process exponentially so that it was much easier to spread news and knowledge.
- A **Steam Jack** driven by a **Steam Turbine** (the earliest practical steam-powered machine) was invented in 1551 by Taqi al-Din Muhammad ibn Ma'ruf in Ottoman Egypt, for automatically rotating a cooking spit.
- During the Renaissance, (14th – 17th centuries CE) the **Dynamics of the Mechanical Powers**, as the simple machines were then called, began to be studied for how much useful work they could perform, leading to the concept of mechanical work. **Georg Bauer** built a water-powered hoist in 1555, for raising ore in mines.

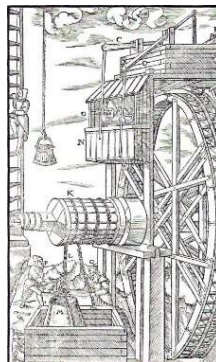

Water-Powered Mine Hoist

[Agricola1 - Engineering - Wikipedia](http://Wikipedia)

- In 1586 **Simon Stevin**, a Flemish engineer, derived the **Mechanical Advantage** of the **Inclined Plane** simple machine.

- A dynamic theory of simple machines was done by Italian scientist **Galileo Galilei** in 1600 (*Le Meccaniche*, On Mechanics). He was the first to show that simple machines do not create energy, but only transform it.
- In 1698 Englishman **Thomas Savery** invented the **Steam Engine**, for removing water from mines. Savery's invention paved the way for Englishman **Thomas Newcomen's** and Scotsman **James Watt's** later steam engines, allowing the beginning of mechanized transportation and the industrial revolution.

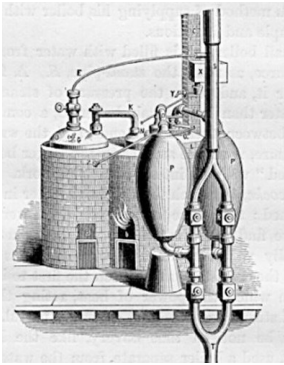

Savery Steam Engine

[e077e12ba2cad3141dd243646c714eccc214329c1 \(bhs4.com\)](https://www.bhs4.com/e077e12ba2cad3141dd243646c714eccc214329c1)

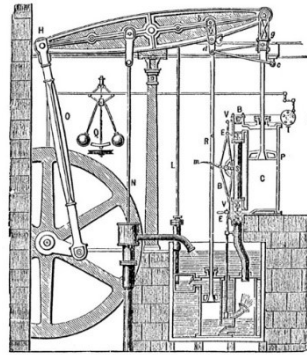

Boulton & Watt Steam Engine

[SteamEngine Boulton&Watt 1784.png \(wikimedia.org\)](https://www.wikimedia.org/wiki/File:SteamEngine_Boulton&Watt_1784.png)

- In 1782 **James Watt** patented an approximate straight-line mechanism, the **Parallel Motion Linkage**, which allowed practical application of the double-acting steam engine. The **Boulton and Watt Steam Engine** (1784) drove steam locomotives, steamships, and factories. English manufacturer **Matthew Boulton** was Watt's financial partner, enabling commercial success of his inventions (that's why his name is first?).
- The **Spinning Jenny**, which could produce multiple spools of thread simultaneously, was invented by **James Hargreaves** in 1764. This moved thread production from the home to the factory. He was unable to patent the concept since he had already sold many of these machines. This was an important innovation during the **Industrial Revolution** (1750 – 1850); changes in agriculture, manufacturing, mining, transportation, and technology that first changed agrarian to more urban societies. The Industrial Revolution started in the United Kingdom, and quickly spread globally. In addition to the mechanization of textile industry, the making of iron and increased use of coal as a power source enabled the Industrial Revolution.



Spinning Jenny

www.thoughtco.com

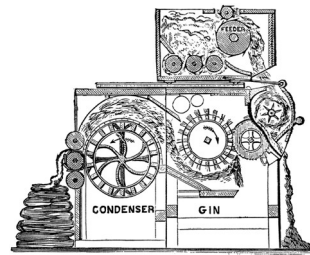

Whitney's Cotton Gin

apushistory.yolasite.com

- In 1794 **Eli Whitney** invented the **Cotton Gin** (despite the original invention in India, 6th century).

- In 1804, the world's first **Steam Locomotive** on rails, the Penyardren, hauled iron ore in Wales. This is the same year **Ohio University** was established.

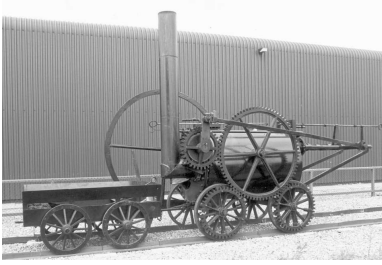

Penyardren Steam Locomotive

[586.png \(museum.wales\)](#)

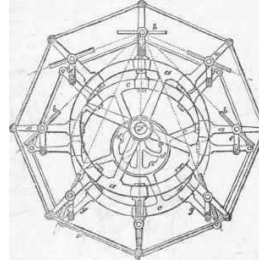

Buchanan Paddle Wheel

[Buchanan-s-Parallel-Float-Wheel.jpg \(chestofbooks.com\)](#)

- In 1813 Scottish civil engineer **Robertson Buchanan** (1770 – 1816) patented a paddle wheel with feathering floats to ensure that the blades always dig in perpendicular to the water.
- In 1816 Scottish minister **Robert Stirling** (1790 – 1878) invented the Stirling Engine (regenerative air engine). This has been a 5+ decades' focus of **Sunpower Inc.** of **Athens Ohio**, started by former Ohio University Mechanical Engineering faculty member **William Beale** in 1965. A spinoff Athens company, **Global Cooling Inc.**, uses Stirling machines for cooling. Some of their coolers have flown on the Space Shuttle, a very complex machine.

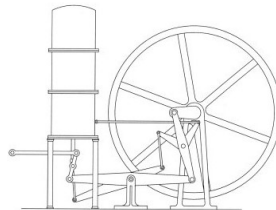

Stirling Engine

[robert-se.jpg \(biglobe.ne.jp\)](#)

- The German **Draisine** in 1817 was the hobby-horse precursor to the **Bicycle**, named in France in the 1860s. As seen in the middle photograph below, today's basic bicycle design was already finished by the **Swift Bicycle Company**, in 1886. In the 1930s a recumbent bicycle dominated a certain bicycle race, so the **International Bicycle Racing Commission** responded by outlawing recumbents in racing, setting back bicycle designs by decades (all current bicycle land-speed record holders are recumbent bicycles).



Draisine



Swift Safety Bicycle



Recumbent Bicycle

- The **Ackermann Steering Linkage** was developed to ensure that both front wheels roll about the same center, as shown in the figure below. This steering linkage avoids tire sideslip during cornering. This linkage was invented in 1817 by German **Georg Lankensperger**, for horse-drawn carriages. His agent **Rudolph Ackermann** patented the device in 1818 in England. I wonder what Georg thought when Rudolph put his own surname on the invention? Modern automobiles use a modified Ackermann Steering Mechanism, to include dynamic and compliant effects.

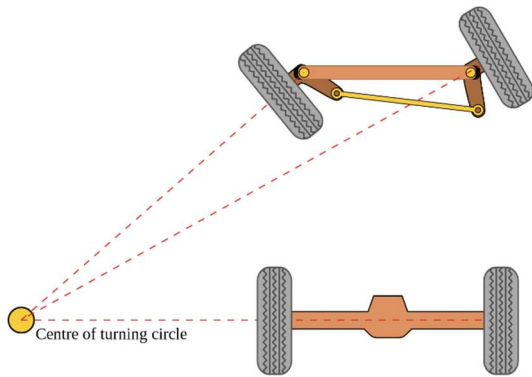

Ackermann Steering Linkage

en.wikipedia.org/wiki/Ackermann_steering_geometry.svg



Thimonnier Sewing Machine

sewing-machine-barthelemy-thimonnier.jpg (slideserve)

- The first **Sewing Machine** was invented by French tailor **Barthelemy Thimonnier** in 1830. French tailors burned his factory, angry that they would lose their jobs due to this machine. In 1834, **Walter Hunt** made America's first sewing machine. **Elias Howe** patented the first **Lockstitch Sewing Machine** in 1846. **Isaac Singer** invented the up-and-down motion mechanism. In 1857, **James Gibbs** patented the first chain-stitch single-thread sewing machine. **Helen Augusta Blanchard** patented the first zig-zag stitch machine in 1873.
- The **Railroad Handcar**, also called a Draisine, Jigger, Kalamazoo, Pump Car, Pump Trolley, and Velocipede, transported riders along railroad rails via human power. Note Draisine and Velocipede are also names of early Bicycles. No one individual or company is given credit for inventing the Railroad Handcar. Instead, this machine arose from various places in the 1840s and was quite common by the time of the U.S. Civil War. The classic machine is driven by a dual-human pumping of a four-bar mechanism.

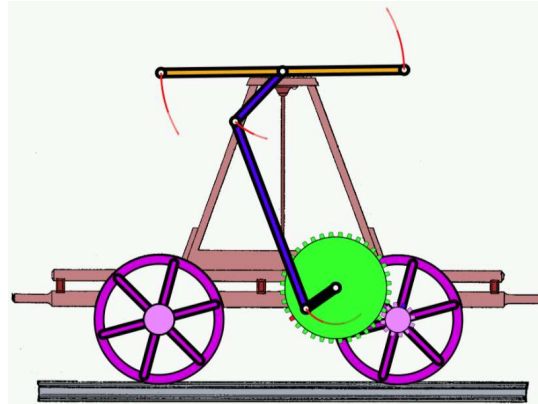

Railroad Handcar

upload.wikimedia.org/wikipedia/commons/e/e0/Hand_Car

- In 1858 Belgian inventor **Etienne Lenoir** invented an **Internal-Combustion Engine** that could be used in motor vehicles. This was a major advancement because it allowed for faster and more efficient travel. People could transport supplies and personal goods easily and it increased trade among companies, causing the economy to grow. For those of you frightened of a hydrogen-powered vehicle, we have forgotten how scared consumers were of riding on a petrol bomb. Of course, those safety concerns have been largely assuaged by engineering.

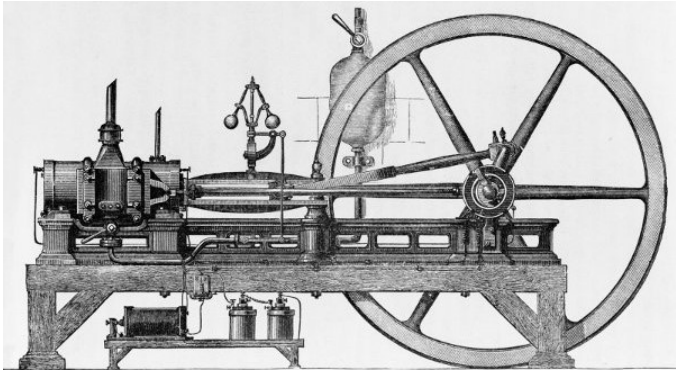

Lenoir Internal Combustion Engine

[Lenoir-first-cumbustion-engine.jpg](#)

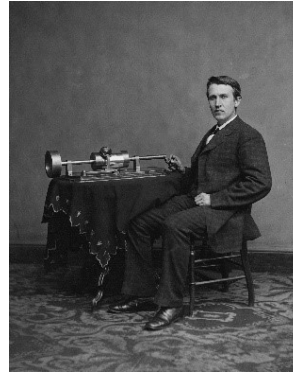

Edison Phonograph

[first working Phonograph](#)

- The first working **Phonograph** was invented in 1877 by **Thomas Edison**.
- **Nikolaus Otto** invented a **Four-Stroke Internal-Combustion Engine** in 1877.

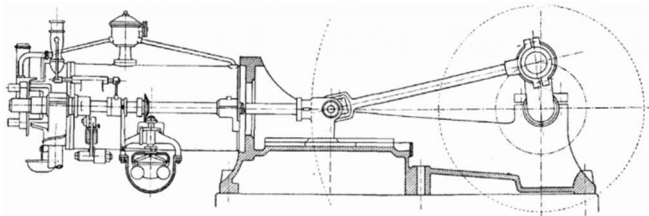

Otto Engine

[L-Verbrennungsmotoren1.png \(scihi.org\)](#)



Benz Automobile

[benz patent 1886 2.jpg \(autoconcept-reviews.com\)](#)

- The world's first practical **Automobile** was designed and produced in 1886 by **Karl Benz**. This car was the first to use an internal combustion engine, paving the way for the practical automobile.

- **Henry Ford** built his first **Automobile** in Michigan in 1886. The **Ford Model-T** was the first affordable, mass-produced car that enabled travel by the middle class in America, in 1908. Ford's main innovation is the assembly line for rapid and standardized, interchangeable manufacturing.



Ford Model T

model-t-ford-recalle.jpg (topspeed.com)

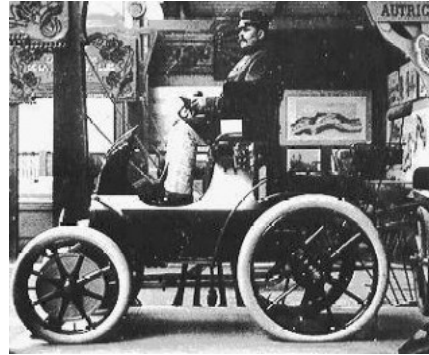

Porsche Hybrid Vehicle

[porsche first Hybrid Gasoline/Electric Vehicle](http://porsche-first-Hybrid-Gasoline/Electric-Vehicle)

- **Ferdinand Porsche** introduced the first **Hybrid Gasoline/Electric Vehicle**, in 1899.
- The dream of a **Flying Car** is almost as old as the automobile itself (actually, older – a gliding horse cart was proposed in the 18th century; since you've never heard of it, perhaps it failed). **Glenn Curtiss** (the Father of Flying Cars) developed the aluminum Autoplane in 1917, with hopping but not flying success. Henry Smolinski and Hal Blake were killed in 1973 moments after takeoff in their 'Flying (Ford) Pinto' creation, after the test pilot failed to show up. Flying Cars are coming (like self-driving cars); we must be prepared safety-wise!



Jetsons Flying Car 2062 (1962)

jetsons.jpg (wordpress.com)

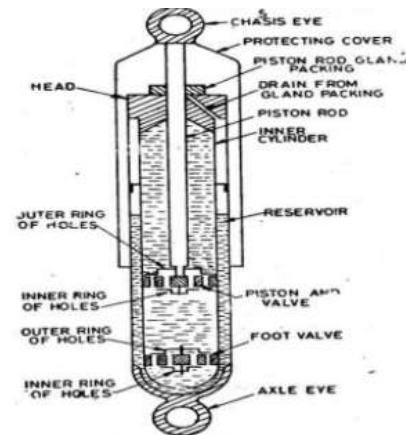

Telescope Shock Absorber

5-shock-absorbers-4-638.jpg (slidesharecdn.com)

- In 1900, the **Telescope Shock Absorber** was developed, consisting of a piston and a cylinder. A one-way valve allows liquid or air to move freely in one direction but stops flow in the opposite direction. This method is still in use today's bicycle shocks and automotive hydraulic suspensions, a spring and viscous dashpot, to smooth out the vehicle ride.

- The first **Retractable Aircraft Landing Gear** was invented in 1911 for the **Glen Curtiss Triad**. They were originally invented for this amphibious aircraft because the landing gear made it difficult to take off and land in the water. In July 2017 two commercial pilots were suspended after their aircraft nearly ran out of fuel because they'd forgotten to retract the landing gear. Perhaps that little task should be automated?

www.dailymail.co.uk/travel/travel_news/article-4739838/Air-India-pilots-forget-raise-landing-gear



First Retractable Aircraft Landing Gear

A Closer Look at Landing Gear, Smithsonian

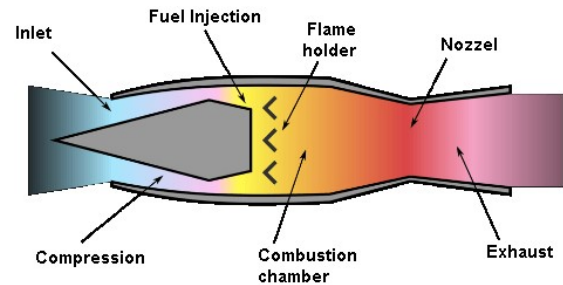

Typical Ramjet Design

[main-qimg \(quoracdn.net\)](http://main-qimg.quoracdn.net)

- **Rene Lorin** invented the **Ramjet** in 1913; he was awarded a patent but failed to build a prototype due to lack of appropriate materials. A ramjet is an air-breathing jet engine that uses forward motion to compress the incoming air, removing the need for a compressor, but also impossible to start from a stopped condition. Therefore, these aircraft must be launched, towed, or piggy-backed to take off. Ramjets are most efficient at Mach 3. A **Scramjet** engine is a Ramjet in which the combustion occurs in a supersonic airflow throughout the engine (despite mach speeds for the aircraft, Ramjet airflow is subsonic in the engine).
- **Leonard Dryer** invented what is now known as the **Crower Six-Stroke Engine** in 1915.

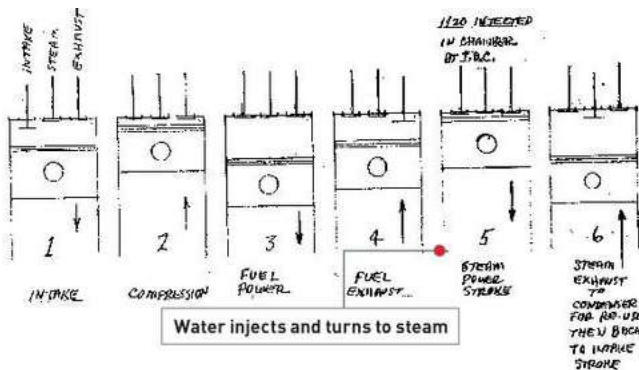

Six-Stroke Engine Phases

[cro.jpg \(bp.blogspot.com\)](http://cro.jpg(bp.blogspot.com))

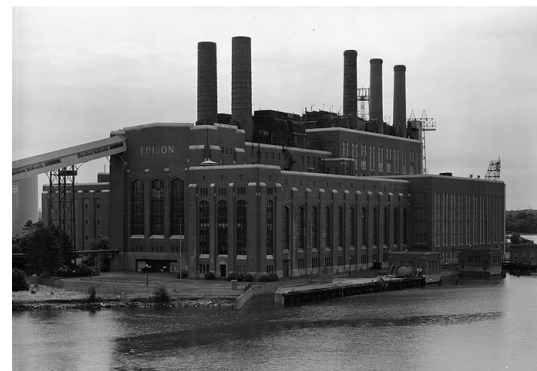

Edgar Power Plant

[Edison-Edgar Station Weymouth.jpg \(wikimedia.org\)](http://Edison-Edgar_Station_Weymouth.jpg(wikimedia.org))

- In 1920 **Boston Edison's Edgar Station** was the first high-pressure **Steam Power Plant** to produce 1kw/h of electricity per 1 lb. of coal. This was 5x – 10x more efficient than its predecessor. This technique worked by operating a turbine with 1200 psi steam pressure.

- The **Horsehead Oil Pump** (a.k.a. Beam Pump, Grasshopper, Nodding Donkey, Pumping Jack, Rocking Horse, and Thirsty Bird) was invented in 1925 by **Walter Trout** in Lufkin, TX. This common machine is based on the four-bar mechanism whose input link incorporates a large flywheel to even out the input torque required and to regulate the input angular velocity.



Horsehead Oil Pump

[horse-head-oil-pump-20490700.jpg](#)



Heinkel He 178 Turbojet

[Flughafen_Rostock-Laage1.jpg \(wikimedia.org\)](#)

- The first flight of an aircraft to fly with a **Jet Engine**, the Heinkel He 178, was in 1939.
- Russian émigré **Igor Sikorsky** developed the **VS-300 Helicopter** for the U.S. Army in 1939, the first practical single-rotor helicopter.



Sikorsky Helicopter

[vought-sik_vs-300.jpg \(aviastar.org\)](#)



Bell X-1 Supersonic Rocket Plane

[XOneInFlight.jpg \(chuckyeager.com\)](#)

- U.S. Air Force pilot **Chuck Yeager** became the fastest man alive when he pilots the **Bell X-1** faster than sound for the first time in 1947 over the town of Victorville, California. Yeager said, “If you want to grow old as a pilot, you’ve got to know when to push it, and when to back off”.
- The first **Artificial Satellite Sputnik** was launched by the USSR in 1957, initiating the space race.

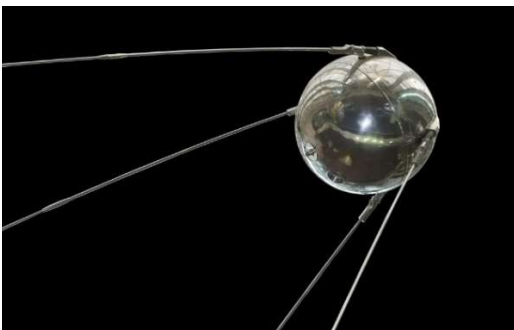

Sputnik

[1-sputnik-34391.jpg \(thefederalist.com\)](#)



PUMA Industrial Robot

[1978puma.jpg \(datapeak.net\)](#)

- **Joseph Engleberger** and **George Devoe** are considered the fathers of **Industrial Robots**. Their company **Unimation** built the first industrial robot, the **PUMA** (Programmable Universal Manipulator Arm, a later version shown above), in 1961.

Here is a true story: I was in San Diego for an IEEE Robotics Conference in 1994, and was lucky to attend a dinner where the keynote speaker was Joseph Engleberger, one of our heroes! During that talk he harangued the room of hundreds to stop working on kinematics research, all those problems are solved! Walking back to our rooms afterwards, Steve Remis, researching singularity-free robot wrists at Notre Dame at the time (**Freudenstein** → **Yang** → **Pennock** → **Stanisic** → **Remis**), told me, ‘Mr. Engleberger, you gotta a lotta dang nerve telling us to quit Kinematics when your stupid robot has a crippling singularity in the middle of the useful workspace for the wrist!’ (clearly evident in the photo above – when the wrist is extended, there are two ways to roll, one to pitch, but instantaneously no way to yaw).

- The first **Personal Computer (PC)** was released in 1965 and was called the **Programma 101**. It was produced by an Italian Manufacturer **Olivetti**. This computer was only capable of calculating the four basic arithmetic functions (add, subtract, multiply, divide) and it cost \$3,200. This is \$26,500 in 2020 currency!



Programma 101 ‘PC’

Olivetti_Programma_101_-_Museo_scienza_e_tecnologia_Milano.jpg

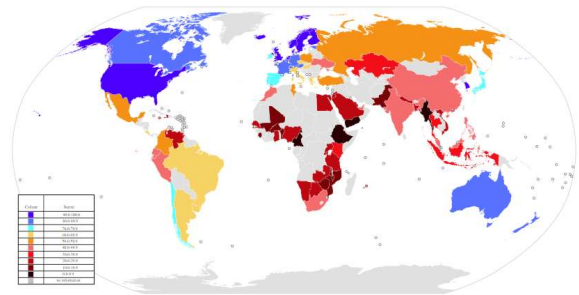

World Wide Web Coverage, 2014

wikimedia.org/wikipedia/commons/6/65/Web_Index.svg

- The **World Wide Web (The Internet)**, **HTML** to create web pages, **http**, and **URLs** are introduced in 1989. It was not invented by Al Gore.
- In the 1990s **Regenerative Braking** was used to partially power hybrid vehicle motors.

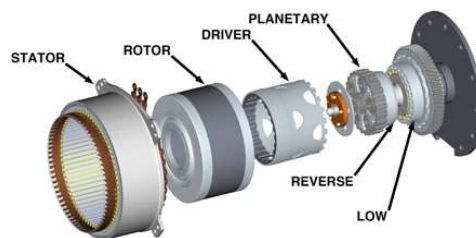

Regenerative Brake, Exploded View

Ac-Motor-Regenerative-Braking1.jpg (bp.blogspot.com)

6. Important Persons in the History of Mechanisms

- **Archimedes** (287–212 BCE) of ancient Greece was one of the first mechanical engineers, way before the field formally existed (mechanical engineering arose with the Industrial Revolution in the nineteenth century). His inventions include epicyclic differential gearing, still in use today.

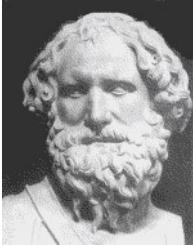

Archimedes

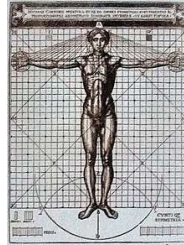

Vitruvius Man

- **Marcus Vitruvius Pollio** (circa 80 – 15 BCE) was a Roman architect and military engineer. He wrote the multi-volume book *De Architectura* circa 28 BCE, highlighting machines to move heavy objects, in addition to the ballista and scorpio siege machines for war. He wrote on perfect proportion in the human body, which inspired **Leonardo da Vinci's Vitruvian Man**.
- **Hero of Alexandria** (circa 10 – 70 CE) was a Greco-Egyptian mathematician and experimenter who is famous for deriving the area of a triangle based only on the side lengths (Heron's Formula). He developed a steam-powered **Aeolipile**, and built a windwheel (the first use of wind power on land). He invented many useful mechanisms, including the first vending machine. Hero published in diverse topics of hydraulics, automata, mechanics, surfaces/volumes, surveying, war engines, and optics.



Hero



Aeolipile



al-Jazari



Elephant Clock

- **Badi'al-Zaman Abu al-'Izz ibn Isma'il ibn al-Razaz al-Jazari** (1136 – 1206) was a Kurdish scholar, inventor, mechanical engineer, craftsman, artist, and mathematician from the Islamic Golden Age. He invented many different mechanisms, water-raising machines, automata, and clocks (such as the **Elephant Clock**). He wrote "The Book of Knowledge of Ingenious Mechanical Devices" in 1206. His family name was not 'al-Jazari'; instead, he came from Jazira in Mesopotamia. He easily wins the longest name award in this history.
- **Leonardo da Vinci** (1452 – 1519) was a true Renaissance man: painter, sculptor, architect, musician, scientist, mathematician, engineer, inventor, anatomist, geologist, cartographer, botanist, and author. As an engineer, he developed concepts ahead of his time. He kept notes of designs for flying machines, instruments of war, solar power, a calculator, an early theory of plate

tectonics, and the double hull for ships, among many other concepts. He designed mechanical devices for manufacturing, war, transportation, and mapped out the human body's internal organs, muscles and bones more thoroughly than anyone before him. Swiss bridge builders use the same methods from da Vinci's notebooks to build arched wooden bridges. He advanced knowledge in anatomy, astronomy, civil engineering, optics, and hydrodynamics. His last commissioned work was a mechanical lion that could walk and open its chest to reveal a bouquet of lilies. Leonardo's last name is not da Vinci – this simply means 'of Vinci', i.e. he was born in this village of the Tuscany region of present-day Italy.



Leonardo

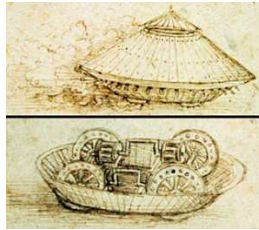

War Tank Concept

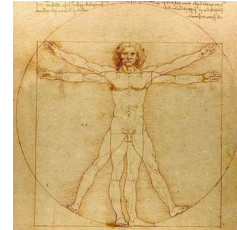

Vitruvian Man

- **Rene Descartes** (1596 – 1650) is the father of analytic geometry. He developed the Cartesian coordinate plane. Please note Cartesian is capitalized, since it is named for him. Descartes was the first to use superscripts for exponents in mathematics. He paved the way for the development of calculus. He was the first to use algebra to describe geometry. He identified the laws of reflection and refraction.



Rene Descartes



Isaac Newton

- **Isaac Newton** (1642 – 1727) invented calculus and discovered the mathematical laws of gravity. He laid the foundation of modern dynamics in *Principia Mathematica Philosophiae Naturalis*, with his three laws of rest and movement. He developed these three universal laws of motion in 1687, and they are still in widespread use in mechanical engineering today:
 1. **Newton's First Law:** An object at rest tends to stay at rest and an object in motion tends to stay in motion with the same speed and in the same direction unless acted upon by an unbalanced external force.
 2. **Newton's Second Law:** The acceleration a of an object as produced by a net force F is directly proportional to the magnitude of the net force, in the same direction as the net force, and inversely proportional to the mass m of the object; $F = ma$ (assuming constant mass). The original Newton statement of this law is a net force F on a body is proportional to the time rate of change of linear momentum of that body.
 3. **Newton's Third Law:** For every action, there is an equal and opposite reaction.

- **Benjamin Franklin** (1706 – 1790) was a U.S. founding father, author, printer, politician, postmaster, statesman, and diplomat. He is in this list due to his fame as a scientist (discoveries and theories on electricity) and an inventor (lightning rod, bifocals, Franklin stove, glass armonica (not misspelled), odometer, Daylight Savings Time, fire departments, political cartoons, and mapping of the Gulf Stream).



Benjamin Franklin



Leonhard Euler

- **Leonhard Euler** (1707 – 1783) was a Swiss mathematician who worked in Germany and Russia. He wrote analytical methods for mechanisms in *Mechanica siva Motus Scientia Analytice Exposita* in 1736. In this work he presented both translational and rotational kinematics for a rigid body. He also suggested the separation of kinematics (pure motion) and kinetics (motion and force/moment), which is continued today. French mathematician **Jean-Baptiste le Rond d'Alembert** (1717 – 1783) proposed similar ideas around the same time. Euler also extended Newton's Second Law to rotational dynamics motion.
- **James Watt** (1736 – 1819) was a Scottish inventor, mechanical engineer, and chemist. He improved the 1712 Newcomen steam engine with the Watt steam engine (1776). Watt developed the idea of horsepower, and the SI unit of power is named after him.



James Watt

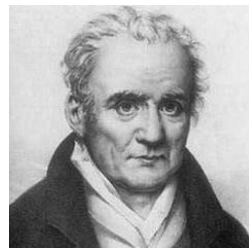

Gaspard Monge

- **Gaspard Monge** (1746 – 1818) was a French professor at the L'Ecole Polytechnic in Paris, teaching a course on machine elements. Along with **Jean Nicolas Pierre Hachette** (1769 – 1834), he published the first modern mechanisms textbook in 1811, enumerating all mechanisms and machines known at the time.

- **Andre-Marie Ampere** (1775 – 1836) was a French physicist and mathematician at the L'Ecole Polytecnic in Paris. In his Essai sur la Philosophie des Sciences, he was the first to use the term '**cinematique**' (from the Greek for motion) to describe the study of motion without regard to forces. This French word was later Anglicized to '**kinematics**' and Germanized to '**kinematik**'. Ampere was also into electricity, and was honored with the naming of the standard electrical current unit as 'Amperes'.



Andre-Marie Ampere



Robert Stirling

- **Robert Stirling** (1790 – 1878) was a Scottish minister who invented the Stirling Hot Air Engine in 1816, which is powered by any heat source, not only steam, which was the input power of the day.
- **Robert Willis** (1800 – 1875) was a reverend and professor at the University of Cambridge, England. He wrote Principles of Mechanism in 1841, systemizing mechanism synthesis.



Robert Willis

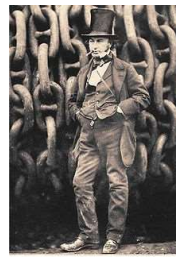

Isambard Kingdom Brunel

- **Isambard Kingdom Brunel** (1806 – 1859) was an English mechanical and civil engineer, considered an engineering giant and influential in the Industrial Revolution. He built dockyards, the Great Western Railway, steamships (including the first trans-Atlantic steamship with propeller), and major bridges and tunnels (the first under a navigable river).

- **Franz Reuleaux** (1829 – 1905) was a German mechanical engineer who is known as the Father of Kinematics. He is credited with formalizing kinematics analysis with rigid links and kinematic pairs (joints). He wrote one of the first ‘modern’ books on the subject (1876).



Franz Reuleaux



Nikolaus Otto

- **Nikolaus Otto** (1832 – 1891) was a German engineer who developed the first successful timed-spark ignition, compressed fuel-air mixture, four-stroke internal combustion engine. The related Otto thermodynamic cycle is named after him.
- **Thomas Crapper** (1836 – 1910) was an English businessman and plumber, with three patents for improvements to the flush toilet. These included the floating ballcock and replacing the S bend with a novel U bend plumbing trap.



Thomas Crapper



Robert Stawell Ball

- **Robert Stawell Ball** (1840 – 1913) was an Irish astronomer, who proposed **Screw Theory**. This involves algebraic calculation of pairs of vectors (forces/moments, linear/ angular velocities) that is useful in the kinematics and dynamics of rigid bodies. Modern roboticists have embraced this theory in robotics research.

- **Thomas Edison** (1847 – 1931) patented 1,093 inventions in his lifetime. Besides his famous light bulb innovation in 1879, Edison developed the phonograph and the kinoscope, a small box for viewing moving films. He also improved upon the original design of the stock ticker, the telegraph, and Alexander Graham Bell's telephone.

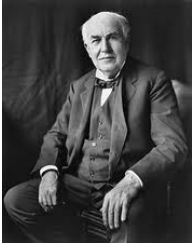

Thomas Edison



Rudolf Diesel

- **Rudolf Diesel** (1858 – 1913) used his understanding of thermodynamics and theoretical plus practical fuel efficiency constraints to create a more efficient motor, the diesel engine.
- **Beulah Louise Henry** (1887 – 1973) was known in the 1920s and 30s as ‘the lady Edison’ for the many inventions she patented, including a vacuum ice cream freezer, a typewriter that made multiple copies without carbon paper, and a bobbinless lockstitch sewing machine. Henry founded manufacturing companies to produce her creations, making a fortune in the process.



Beulah Louise Henry

7. Definitions

kinematics	The study of motion without regard to forces/torques. From the Greek, kinema for <i>motion</i> .
dynamics	The study of motion with regard to forces/torques. From the Greek, dynamikos for <i>powerful</i> .
statics	The study of forces/torques without regard to motion. The study of force/moment equilibrium in structures.
free-body diagram (FBD)	A diagram drawn out of context for each separate link mass/inertia with all external and internal forces and moments shown to give the context.
mobility (M)	The number of degrees-of-freedom of a device.
degrees-of-freedom (dof)	The number of independent parameters required to fully specify the location of a device. The number of motors required to drive a device.
planar motion	Two-dimensional (2D) motion (projected onto a common plane) with two independent translations XY and one independent rotation, pitch.
spatial motion	Three-dimensional (3D) motion with three independent translations XYZ and three independent rotations, roll, pitch, and yaw.
robot	A device with more than one degrees-of-freedom.
mechanism	A device with one degree-of-freedom.
structure	A device with zero degrees-of-freedom (statically-determinate structure) or less than zero degrees-of-freedom (statically-indeterminate structure); i.e. having no motion.
machine	A mechanical device that takes input power to apply forces and moments in order to accomplish desired tasks.
engine	A machine used to power vehicles. Engine derives from the Latin ingenium meaning ‘innate quality, mental power, clever invention’. In French, the word for ‘engineer’ (from the same Latin root) literally means ‘creator’.
input	The external forcing element that drives a mechanism (or robot).
actuator	The input element (motor) of a mechanism (or robot).
output	The variable of interest in motion of a mechanism (or robot).

linkage	A mechanism consisting of links connected by joints.
gear train	A mechanism consisting of toothed wheels converting angular speed and torque between shafts.
cam/follower	A mechanism consisting of a lobed disk and a translating or rotating output.
link	A body capable of motion.
ground link	The fixed link incapable of motion. Also called the base or frame. There can only be one ground link in a mechanism (or robot).
joint	A pairing element connecting (and allowing motion) between two links. Subdivided into lower-pair and higher-pair joints.
revolute joint (R)	A 1-dof rotating lower-pair joint.
prismatic joint (P)	A 1-dof sliding lower-pair joint.
gear joint (G)	A 2-dof sliding and rotating higher-pair joint between the teeth of two gears.
cam joint (C)	A 2-dof sliding and rotating higher-pair joint between a cam and its follower.
slotted-pin joint (SP)	A 2-dof sliding and rotating higher-pair joint between a pin on a link and a slot on another link.
analysis	Determination of translational and rotational position, velocity, acceleration, and dynamic forces for a given mechanism in motion.
synthesis	Design of an unknown mechanism to accomplish a specific task.

References

Kinematics/Dynamics of Mechanisms/Robots Books / Articles

Franz Reuleaux, 1876, The Kinematics of Machinery. Outlines of a Theory of Machines, English translation by Alexander B. W. Kennedy, MacMillan and Co., London.

Ludwig E. H. Burmester, 1888, Lehrbuch der Kinematik, Verlag, Leipzig.

Francis Rendel Erskine Crossley, 1954, Dynamics in Machines, Ronald Press Co., New York, NY.

J. Denavit and R.S. Hartenberg, 1955, A Kinematic Notation for Lower-Pair Mechanisms Based on Matrices, *Journal of Applied Mechanics*.

H.H. Mabie and C.F. Reinholtz, 1987, Mechanisms and Dynamics of Machinery, fourth edition, John Wiley & Sons, New York, NY (first edition 1957 with Prof. Fred W. Ocvirk).

Allen S. Hall Jr., 1961, Kinematics and Linkage Design, Prentice-Hall, New York, NY.

Kurt Hain, 1967, Applied Kinematics, second edition, McGraw-Hill, New York, NY.

Roger E. Kaufman, 1971, “KINSYN - An Interactive Kinematic Design System”, Third World Congress on Theory of Machines and Mechanisms, September 13-20, Dubrovnik, Yugoslavia.

Chung Suh and Charles W. Radcliffe, 1983, Kinematics and Mechanisms Design, second edition, Krieger Publishing Co, Malabar, FL. (first edition 1978).

Kenneth H. Hunt, 1979, Kinematic Geometry of Mechanisms, Oxford Engineering Science Series, Oxford England.

John J. Uicker, Gordon R. Pennock, and Joseph E. Shigley, 2003, Theory of Machines and Mechanisms, Oxford University Press, New York, NY (first edition 1980).

Fan Y. Chen, 1982, Mechanics and Design of Cam Mechanisms, Pergamon Press, Oxford England.

R.P. Paul, 1983, Robot Manipulators: Mathematics, Programming, and Control, MIT Press, Cambridge, MA.

Arthur G. Erdman, George N. Sandor, and Sridhar Kota, 2001, Mechanism Design: Analysis and Synthesis, fourth edition, Prentice-Hall, New York, NY (first edition 1984).

J.J. Craig, 2005, Introduction to Robotics: Mechanics and Control, third edition, Pearson Prentice Hall, Upper Saddle River, NJ (first edition 1986). Dr. Bob contributed MATLAB assignments to the third edition.

Robert L. Norton, 2019, Design of Machinery: An Introduction to the Synthesis and Analysis of Mechanisms and Machines, sixth edition, McGraw-Hill, New York, NY (first edition 1991).

Joseph Duffy, 1996, Statics and Kinematics with Applications to Robotics, first edition, Cambridge University Press, Cambridge, England.

Larry L. Howell, 2001, Compliant Mechanisms, Wiley Interscience, New York, NY.

Marco Ceccarelli, 2007, Distinguished Figures in Mechanism and Machine Science: Their Contributions and Legacies Part 1, Springer, New York, NY.

Internet Resources

[https://en.wikipedia.org/wiki/Mechanism_\(engineering\)](https://en.wikipedia.org/wiki/Mechanism_(engineering))

<https://en.wikipedia.org/wiki/Machine>

https://en.wikipedia.org/wiki/South-pointing_chariot

https://en.wikipedia.org/wiki/Hierapolis_sawmill

[https://en.wikipedia.org/wiki/Linkage_\(mechanical\)](https://en.wikipedia.org/wiki/Linkage_(mechanical))

https://en.wikipedia.org/wiki/Peaucellier%E2%80%93Lipkin_linkage

<https://en.wikipedia.org/wiki/Pantograph>

<https://en.wikipedia.org/wiki/Gear>

<https://en.wikipedia.org/wiki/Cam>

Dr. Bob NotesBooks

Mechanism Kinematics & Dynamics, Dr. Bob Productions, ©2021

www.lulu.com/content/e-book/mechanism-kinematics-dynamics/20797952

Linear Systems Control for Mechanical Engineers, Dr. Bob Productions, ©2021

www.lulu.com/content/e-book/linear-systems-control-for-mechanical-engineers/20813031

Mechanical Vibrations, Dr. Bob Productions, ©2017

www.lulu.com/content/e-book/mechanical-vibrations/20853410

Engineering Biomechanics of Human Motion, Dr. Bob Productions, 2021

www.lulu.com/content/e-book/engineering-biomechanics-of-human-motion/20853532

Robot Mechanics, Dr. Bob Productions, ©2020

www.lulu.com/content/e-book/robot-mechanics/20853448